

INDEX



GRIFERÍA MONOMANDO REDONDA

- Pag. 06 Roma series ●●
- Pag. 18 Dinamarca series ●●○
- Pag. 30 Milos series ●●
- Pag. 46 Escocia series ●●
- Pag. 50 Luxor series ●●○
- Pag. 62 Elba series ●●
- Pag. 70 Milan series ●●
- Pag. 74 Paris series ●●
- Pag. 78 Sintra series ●●
- Pag. 82 Nassau series ●●
- Pag. 88 Madrid series ●●
- Pag. 92 Olimpo series ●●●
- Pag. 104 Moscú series ●●
- Pag. 110 Córcega series ●●
- Pag. 114 Teide series ●●



GRIFERÍA TERMOSTÁTICA

- Pag. 210 Kent series ●●
- Pag. 212 Creta series ●●
- Pag. 216 Amsterdam series ●●
- Pag. 218 Praga series ●●
- Pag. 220 Londres series ●●○
- Pag. 226 Bled series ●●
- Pag. 228 Vigo series ●●○
- Pag. 232 Sidney series ●●



GRIFERÍA DE COCINA

- Pag. 378 Torino series ●●
- Pag. 380 Samoa series ●●○●
- Pag. 384 Menorca series ●●
- Pag. 388 Itaca series ●●
- Pag. 392 Manacor series ●●○
- Pag. 396 Olimpo series ●●●
- Pag. 402 Lanzarote series ●●
- Pag. 404 Toulouse series ●●
- Pag. 406 Laos series ●●○
- Pag. 408 Malta series ●●○
- Pag. 414 Venecia series ●●
- Pag. 416 Constanza series ●●
- Pag. 418 Pireo series ●●
- Pag. 420 Capri series ●●
- Pag. 422 Montecarlo series ●●
- Pag. 424 Marsella series ●●
- Pag. 426 Lyon series ●●
- Pag. 428 Mikonos series ●●
- Pag. 440 Cox series ●●
- Pag. 432 Verona series ●●
- Pag. 433 Viena series ●●
- Pag. 436 Tokyo series ●●



GRIFERÍA MONOMANDO CUADRADA

- Pag. 122 Valencia series ●●
- Pag. 128 Suecia series ●●●●
- Pag. 144 Art series ●●○
- Pag. 158 Bremen series ●●
- Pag. 162 Liverpool series ●●
- Pag. 166 Saona series ●●
- Pag. 170 Bristol series ●●
- Pag. 174 Nantes series ●●
- Pag. 178 Fiyi series ●●○
- Pag. 196 Bali series ●●
- Pag. 202 Europa series ●●
- Pag. 204 Minsk series ●●



DUCHAS EMPOTRADAS

- Pag. 236 Aruba series ●●
- Pag. 238 Bahamas series ●●○
- Pag. 244 Borneo series ●●
- Pag. 246 Oslo series ●●
- Pag. 249 Mónaco series ●●
- Pag. 250 Dublín series ●●○
- Pag. 253 Berlín series ●●
- Pag. 258 Volga series ●●
- Pag. 258 Gales series ●●
- Pag. 260 Sumatra series ●●
- Pag. 262 Rodas series ●●
- Pag. 266 Málaga series ●●
- Pag. 268 Formentera series ●●
- Pag. 270 Java series ●●
- Pag. 272 Italia series ●●
- Pag. 275 Francia series ●●
- Pag. 276 Noruega series ●●
- Pag. 279 Finlandia series ●●
- Pag. 282 Ons series ●●
- Pag. 283 Cies series ●●○
- Pag. 286 Milos series ●●○●
- Pag. 288 Thalos series ●●
- Pag. 296 Moscú series ●●
- Pag. 302 Madeira series ●●
- Pag. 305 Portugal series ●●
- Pag. 310 Hidra series ●●
- Pag. 313 Ferroe serie ●●
- Pag. 318 Olimpo series ●●●
- Pag. 321 Vesubio series ●●●
- Pag. 330 Suecia series ●●●●
- Pag. 333 Estocolmo serie ●●●●
- Pag. 350 Malta series ●●
- Pag. 351 Suiza series ●●○
- Pag. 354 Fiyi series ●●○
- Pag. 358 Milos series ●●○●
- Pag. 362 Etna series ●●○
- Pag. 368 Olimpo serie ●●●
- Termostáticos
- Pag. 362 empotrados ●●
- Monomandos
- Pag. 373 empotrados ●●

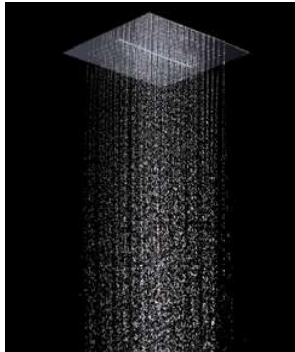

ROCIADORES

Pag. 438 Rociadores



BIDÉS EMPOTRADOS

Pag. 458 Munich series ●●
 Pag. 462 Suecia series ●●●●●
 Pag. 470 Maui series ●
 Pag. 472 Irlanda series ●
 Pag. 474 Ness series ●



ACCESORIOS DE DUCHA

Pag. 476 Accesorios de ducha



MANGOS DE DUCHA

Pag. 488 Austin series ●●○
 Pag. 489 New York series ●●○
 Pag. 490 Henk series ●●○
 Pag. 491 Genova series ●●○
 Pag. 493 Kansas series ●
 Pag. 493 Nevada series ●
 Pag. 494 Denver series ●



VÁLVULAS DE CLICK CLACK Y COMPLEMENTOS

Pag. 496 Válvulas de click clack y complementos



COMPLEMENTOS, REPUESTOS Y EXPOSITORES

Pag. 504 Complementos y repuestos
 Pag. 512 Expositores

ACABADOS

- Cromado
- Negro mate
- Blanco mate
- Negro mate / Oro rosa
- Negro mate / Oro
- Ⓜ Acero inox.





GRIFERÍA MONOMANDO REDONDA

Modelos de líneas curvas y redondas que aportan al baño confort, elegancia y bienestar.

A black pedestal sink with a chrome faucet is the central focus. Above it is a large, dark, rectangular mirror with a subtle glow. To the right, a tall, arched window with a white frame and decorative mullions allows light into the room. The walls are made of rough, grey stone or plaster. In the bottom right corner, a white ceramic pedestal holds a bowl of fruit and a bottle. The overall aesthetic is modern and industrial, set in a rustic environment.

ROMA

SERIE



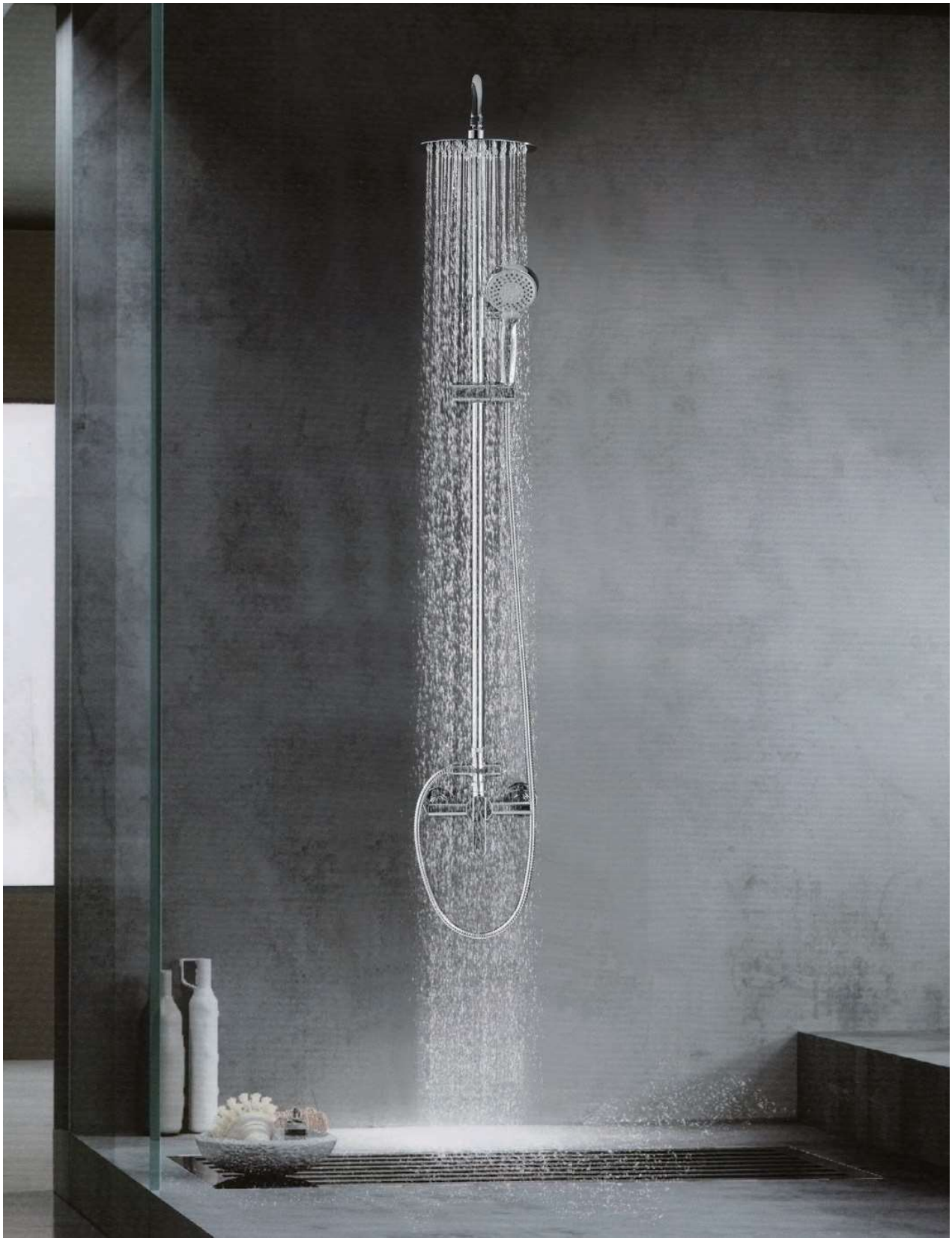

ROMA

SERIE



Un producto elegante y sobrio con una tecnología insuperable.



ROMA

SERIE

Modelo polivalente y adaptable a cualquier baño.
Robustez y sobriedad son sus principales cualidades.



Ref.: BDR001 **Precio: 145 €**
IVA NO INCLUIDO

Barra de ducha extensible de acero inox. extensible 95/132cm.
Rociador de acero inox. redondo Ø20cm, extraplano, cromado y antical.
Soporte teléfono regulable en altura.
Mango ducha redondo de 3 posiciones.
Grifería de latón cromado.
Presión máximo 6 at. mínimo 1 at.
Caudal medio 12 l/min.
Distribuidor redondo de latón cromado.
Flexo reforzado 1,5 m
Cartucho cerámico de 35 mm.

9 780201 379055

Grifería con certificación ACS 25 YEARS

Ref.: BDR001-1 **Precio: 53 €**
IVA NO INCLUIDO

Monomando de lavabo.
Cuerpo de grifería en Latón cromado.
Cartucho cerámico de 35 mm.
Flexos 3/8

9 780201 370126

Grifería con certificación ACS 25 YEARS

Ref.: BDR001-2 **Precio: 54 €**
IVA NO INCLUIDO

Monomando de bidé.
Cuerpo de grifería en Latón cromado.
Cartucho cerámico de 35 mm.
Flexos 3/8

9 780201 370225

Grifería con certificación ACS 25 YEARS

Ref.: BDR001-3 **Precio: 89 €**
IVA NO INCLUIDO

Monomando de lavabo alto.
Cuerpo de grifería en Latón cromado.
Cartucho cerámico de 35 mm.
Flexos 3/8

8 478023 772907

Grifería con certificación ACS 25 YEARS



Ref.: **BDR001-4**

Grifería baño / ducha de latón cromado
 Flexo de acero reforzado 1,8 m
 Soporte para mando de ducha de ABS
 Mango ducha redondo.
 Presión máximo 6 at, mínimo 1 at.
 Caudal medio 12 l/min
 Cartucho monomando cerámico de 35mm

Precio: **84 €**
 IVA NO INCLUIDO

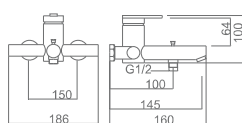

Ref.: **BDR001-5**

Grifería ducha de latón cromado
Flexo de acero reforzado 1,8 m
Soporte para mando de ducha de ABS
Mango ducha redondo.
Presión máximo 6 at, mínimo 1 at.
Caudal medio 12 l/min
Cartucho monomando cerámico de 35mm

Precio: **63 €**
IVA NO INCLUIDO



Grifería con
certificación
ACS

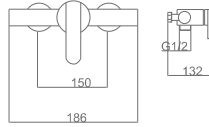

Modelo polivalente y adaptable a cualquier baño. Robustez y sobriedad son sus principales cualidades.





ROMA
NEGRO MATE
SERIE





Ref.: **BDR002** Precio: **174 €**
IVA NO INCLUIDO

Barra de ducha extensible de acero inox. negro mate, extensible 95/127cm.
Rociador de acero inox. redondo Ø20cm, extraplano, negro mate y antical.
Soporte teléfono regulable en altura.
Mango ducha redondo de 3 posiciones.
Grifería de latón negro mate.
Presión máximo 6 at. mínimo 1 at.
Caudal medio 12 l/min.
Distribuidor redondo de latón negro mate.
Flexo PVC negro mate 1,5 m
Cartucho cerámico de 35 mm.



Ref.: **BDR002-1** Precio: **63 €**
IVA NO INCLUIDO

Monomando de lavabo.
Cuerpo de grifería en Latón negro mate.
Cartucho cerámico de 35 mm.
Flexos 3/8

Grifería con certificación

Ref.: **BDR002-2** Precio: **64 €**
IVA NO INCLUIDO

Monomando de bidé.
Cuerpo de grifería en Latón negro mate.
Cartucho cerámico de 35 mm.
Flexos 3/8

Grifería con certificación

DINAMARCA

SERIE





DINAMARCA

SERIE



Modelos de líneas curvas y redondas que aportan al baño confort, elegancia y bienestar.

Ref.: **BDR031/CR** Precio: **171 €**
IVA NO INCLUIDO

Barra de ducha cromo extensible de acero inox. 304 de 88/125cm.
Rociador de acero inox. redondo Ø20cm,extraplano,cromado y antical.
Soporte teléfono regulable en altura.
Mango ducha redondo de 1 posición.
Grifería de latón cromado.
Presión máximo 6 at,mínimo 1 at.
Caudal medio 12 l/min.
Distribuidor integrado en la grifería.
Flexo reforzado 1,5 m
Cartucho monomando cerámico de 35mm.

Ref.: **BDR031-1CR** Precio: **59 €**
IVA NO INCLUIDO

Monomando de lavabo.
Cuerpo de grifería en Latón cromado.
Cartucho cerámico de 25 mm.
Flexos 3/8.

Ref.: **BDR031-2CR** Precio: **57 €**
IVA NO INCLUIDO

Monomando de bidé.
Cuerpo de grifería en Laton cromado.
Cartucho cerámico de 25 mm.
Flexos 3/8.

Ref.: **BDR031-3CR** Precio: **89 €**
IVA NO INCLUIDO

Monomando de lavabo alto.
Cuerpo de grifería en Latón cromado.
Cartucho cerámico de 25 mm.
Flexos 3/8.



DINAMARCA NEGRO MATE

SERIE



DINAMARCA

SERIE

Modelos de líneas curvas y redondas que aportan al baño confort, elegancia y bienestar.



Ref.: BDR031/NG Precio: 193 €
IVA NO INCLUIDO

Barra de ducha extensible de acero inox. extensible 88/125 cm, en negro mate.
Rociador de acero inox. redondo Ø20cm, extraplano, negro mate y antical.
Soporte teléfono regulable en altura.
Mango de ducha redondo de 1 posición en negro mate.
Grifería de latón negro mate.
Presión máximo 6 at, mínimo 1 at.
Caudal medio 12 l/min.
Distribuidor integrado en la grifería, en negro mate.
Flexo PVC 1,5 m
Cartucho monomando cerámico de 35mm

Ref.: BDR031-1NG Precio: 61 €
IVA NO INCLUIDO

Monomando de lavabo.
Cuerpo de grifería en Latón negro mate.
Cartucho cerámico de 25 mm.
Flexos 3/8.

Ref.: BDR031-2NG Precio: 58 €
IVA NO INCLUIDO

Monomando de bidé.
Cuerpo de grifería en Latón negro mate.
Cartucho cerámico de 25 mm.
Flexos 3/8.

Ref.: BDR031-3NG Precio: 104 €
IVA NO INCLUIDO

Monomando de lavabo alto.
Cuerpo de grifería en Latón negro mate.
Cartucho cerámico de 25 mm.
Flexos 3/8.



DINAMARCA

SERIE

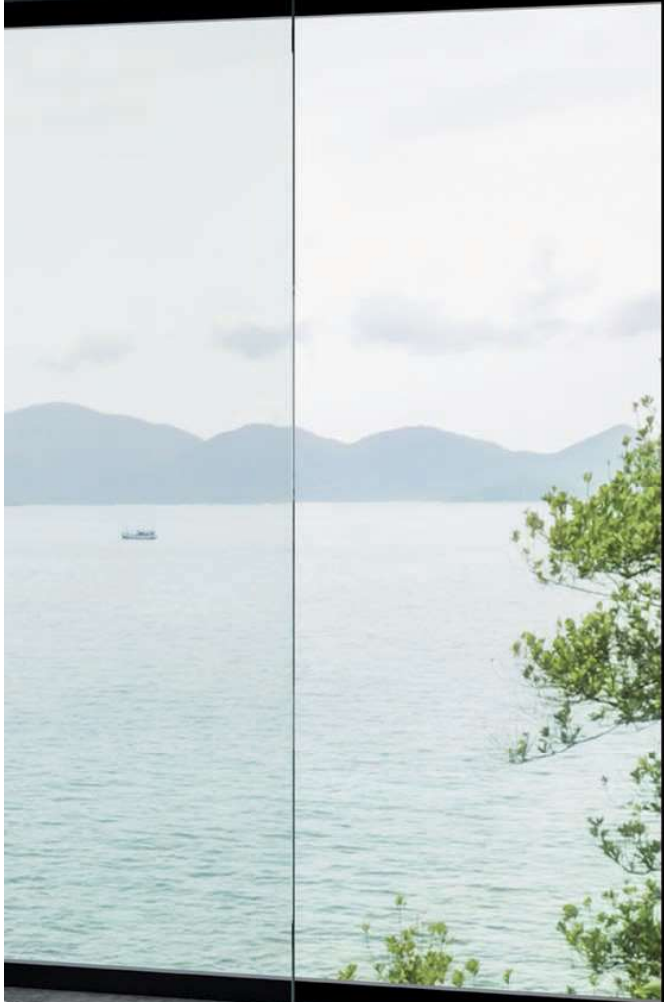

DINAMARCA

BLANCO MATE

SERIE



Ref.: BDR031/BL Precio: 193 €
IVA NO INCLUIDO

Barra de ducha extensible de acero inox. extensible 88 / 125 cm, en blanco mate.
Rociador de acero inox. redondo Ø20cm, extraplano, blanco mate y antical.
Soporte teléfono regulable en altura.
Mango de ducha redondo de 1 posición en blanco mate.
Grifería de latón blanco mate.
Presión máximo 6 at, mínimo 1 at.
Caudal medio 12 l/min.
Distribuidor integrado en la grifería en blanco mate.
-Flexo PVC de 1,5 m en blanco mate.
Cartucho monomando cerámico de 35mm

Ref.: BDR031-1BL Precio: 61 €
IVA NO INCLUIDO

Monomando de lavabo.
Cuerpo de grifería en Latón blanco mate.
Cartucho cerámico de 25 mm.
Flexos 3/8.

Ref.: BDR031-2BL Precio: 58 €
IVA NO INCLUIDO

Monomando de bidé.
Cuerpo de grifería en Latón blanco mate.
Cartucho cerámico de 25 mm.
Flexos 3/8.

Ref.: BDR031-3BL Precio: 104 €
IVA NO INCLUIDO

Monomando de lavabo alto.
Cuerpo de grifería en Latón blanco mate.
Cartucho cerámico de 25 mm.
Flexos 3/8.

MILOS

SERIE



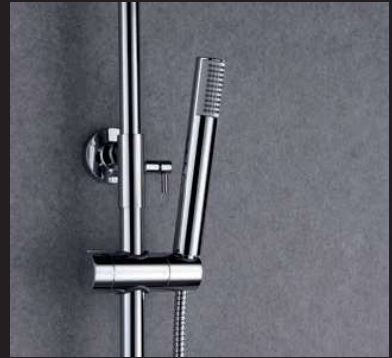

Modelos de líneas curvas y redondas que aportan al baño confort, elegancia y bienestar.

MILOS

SERIE

Modelos de líneas curvas y redondas que aportan al baño confort, elegancia y bienestar.



Ref.: **BDY027** Precio: **170 €**
IVA NO INCLUIDO

Barra de ducha extensible de acero inox. cromado, extensible 95/132,5 cm.
Rociador de acero inox. redondo Ø20cm, extraplano, cromado y antical.
Soporte teléfono regulable en altura.
Mango ducha redondo de 1 posición.
Grifería de latón cromado.
Presión máximo 6 at. mínimo 1 at.
Caudal medio 12 l/min.
Distribuidor redondo de latón cromado.
Flexo reforzado 1,5 m
Cartucho cerámico de 35 mm.

Ref.: **BDY027-1CR** Precio: **66 €**
IVA NO INCLUIDO

Monomando de lavabo.
Cuerpo de grifería en Latón cromado.
Cartucho cerámico de 25 mm.
Flexos 3/8

Ref.: **BDY027-2CR** Precio: **73 €**
IVA NO INCLUIDO

Monomando de bidé.
Cuerpo de grifería en Latón cromado.
Cartucho cerámico de 25 mm.
Flexos 3/8

Ref.: **BDY027-3CR** Precio: **93 €**
IVA NO INCLUIDO

Monomando de lavabo alto.
Cuerpo de grifería en Latón cromado.
Cartucho cerámico de 25 mm.
Flexos 3/8



MILOS
NEGRO MATE
SERIE



MILOS

NEGRO MATE

SERIE



Modelos de líneas curvas y redondas que aportan al baño confort, elegancia y bienestar.



Ref: **BDY027/NG** Precio: **207 €**
IVA NO INCLUIDO

Barra de ducha extensible de acero inox. negro mate, extensible 95/132,5 cm.
Rociador de acero inox. redondo Ø20cm, extraplano, negro mate y antical.
Soporte teléfono regulable en altura.
Mango ducha redondo de 1 posición.
Grifería de latón negro mate.
Presión máximo 6 at. mínimo 1 at.
Caudal medio 12 l/min.
Distribuidor redondo de latón negro mate.
Flexo reforzado de PVC negro mate 1,5 m
Cartucho cerámico de 35 mm.

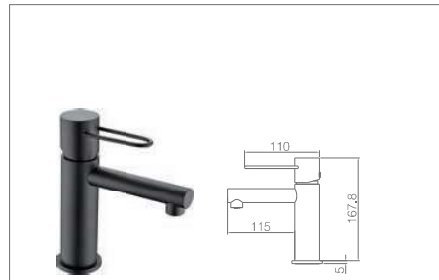

Ref: **BDY027-1NG** Precio: **81 €**
IVA NO INCLUIDO

Monomando de lavabo.
Cuerpo de grifería en Latón negro mate.
Cartucho cerámico Citec de 25 mm.
Flexos 3/8



Ref: **BDY027-2NG** Precio: **84 €**
IVA NO INCLUIDO

Monomando de bidé.
Cuerpo de grifería en Latón negro mate.
Cartucho cerámico Citec de 25 mm.
Flexos 3/8



Ref: **BDY027-3NG** Precio: **108 €**
IVA NO INCLUIDO

Monomando de lavabo alto.
Cuerpo de grifería en Latón negro mate.
Cartucho cerámico Citec de 25 mm.
Flexos 3/8



MILOS

NEGRO ORO ROSA

SERIE





MILOS

NEGRO ORO ROSA

SERIE



Modelos de líneas curvas y redondas que aportan al baño confort, elegancia y bienestar.



Ref.: **BDY027/NOR** Precio: **239 €**
IVA NO INCLUIDO

Barra de ducha extensible de acero inox. negro mate, extensible 95/132,5 cm.
Rociador de acero inox. redondo Ø20cm, extraplano, oro rosa y antical.
Soporte teléfono regulable en altura.
Mango ducha redondo de 1 posición.
Grifería de latón negro oro rosa.
Presión máximo 6 at. mínimo 1 at.
Caudal medio 12 l/min.
Distribuidor redondo de latón negro mate.
Flexo reforzado de PVC negro mate 1,5 m
Cartucho cerámico de 35 mm.



Ref.: **BDY027-1NOR** Precio: **93 €**
IVA NO INCLUIDO

Monomando de lavabo.
Cuerpo de grifería en Latón negro oro rosa.
Cartucho cerámico de 25 mm.
Flexos 3/8



Ref.: **BDY027-2NOR** Precio: **97 €**
IVA NO INCLUIDO

Monomando de bidé.
Cuerpo de grifería en Latón negro oro rosa.
Cartucho cerámico de 25 mm.
Flexos 3/8



Ref.: **BDY027-3NOR** Precio: **121 €**
IVA NO INCLUIDO

Monomando de lavabo alto.
Cuerpo de grifería en Latón negro oro rosa.
Cartucho cerámico de 25 mm.
Flexos 3/8





MILOS BLANCO MATE

SERIE

Modelos de líneas curvas y redondas que aportan al baño confort, elegancia y bienestar.



MILOS

BLANCO MATE

SERIE

Modelos de líneas curvas y redondas que aportan al baño confort, elegancia y bienestar.





Ref: **BDY027/BL** Precio: **207 €**
IVA NO INCLUIDO

Barra de ducha extensible de acero inox. blanco mate, extensible 95/132,5 cm.
Rociador de acero inox. redondo Ø20cm, extraplano, blanco mate y antical.
Soporte teléfono regulable en altura.
Mango ducha redondo de 1 posición.
Grifería de latón blanco mate.
Presión máximo 6 at. mínimo 1 at.
Caudal medio 12 l/min.
Distribuidor redondo de latón blanco mate.
Flexo reforzado PVC blanco mate 1,5 m
Cartucho cerámico de 35 mm.

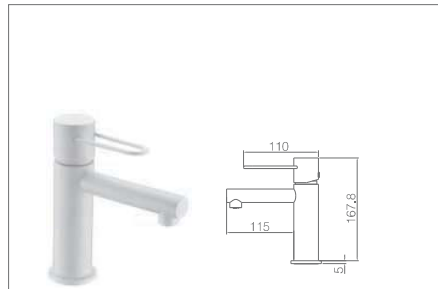

Ref: **BDY027-1BL** Precio: **81 €**
IVA NO INCLUIDO

Monomando de lavabo.
Cuerpo de grifería en Latón blanco mate.
Cartucho cerámico de 25 mm.
Flexos 3/8

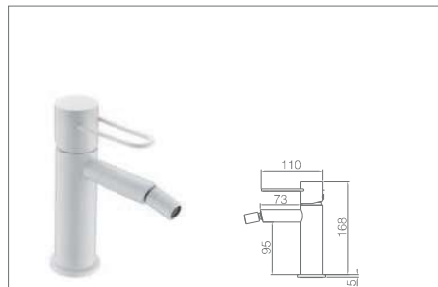

Ref: **BDY027-2BL** Precio: **84 €**
IVA NO INCLUIDO

Monomando de bidé.
Cuerpo de grifería en Latón blanco mate.
Cartucho cerámico de 25 mm.
Flexos 3/8

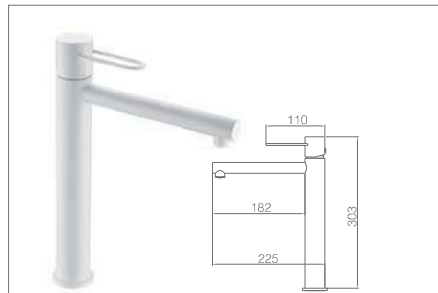

Ref: **BDY027-3BL** Precio: **108 €**
IVA NO INCLUIDO

Monomando de lavabo alto.
Cuerpo de grifería en Latón blanco mate.
Cartucho cerámico de 25 mm.
Flexos 3/8





ESCOCIA

SERIE



Modelos de líneas curvas y redondas que aportan al baño confort, elegancia y bienestar.

ESCOCIA

SERIE

Modelos de líneas curvas y redondas que aportan al baño confort, elegancia y bienestar.



Sistema desvío de agua de mango a rociador: girar y bajar.

Ref.: **BDSC024** Precio: **179 €**
IVA NO INCLUIDO

Barra de ducha extensible de acero inox. extensible 87/123 cm.
Rociador de acero inox. redondo Ø20cm, extraplano, cromado y antical.
Soporte teléfono regulable en altura.
Mango ducha redondo de 3 posiciones.
Grifería de latón cromado.
Presión máximo 6 at. mínimo 1 at.
Caudal medio 12 l/min.
Distribuidor redondo de latón cromado.
Flexo reforzado 1,5 m
Cartucho cerámico de 35 mm.

Ref.: **BDSC024-1** Precio: **79 €**
IVA NO INCLUIDO

Monomando de lavabo.
Cuerpo de grifería en Latón cromado.
Cartucho cerámico de 35 mm.
Flexos 3/8

Ref.: **BDSC024-2** Precio: **59 €**
IVA NO INCLUIDO

Monomando de bidé.
Cuerpo de grifería en Latón cromado.
Cartucho cerámico de 35 mm.
Flexos 3/8

Ref.: **BDSC024-3** Precio: **119 €**
IVA NO INCLUIDO

Monomando de lavabo.
Cuerpo de grifería en Latón cromado.
Cartucho cerámico de 35 mm.
Flexos 3/8



LUXOR

SERIE

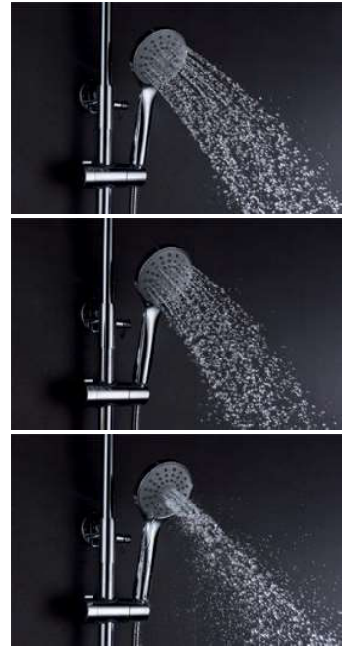

Modelos de líneas curvas y redondas que aportan al baño confort, elegancia y bienestar.



LUXOR

SERIE



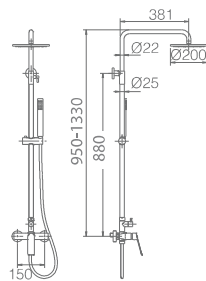

Ref.: **BDX023** Precio: **159 €**
IVA NO INCLUIDO

Barra de ducha extensible de acero inox. extensible 95/133cm.
Rociador de acero inox. redondo Ø20cm, extraplano, cromado y antical.
Soporte teléfono regulable en altura.
Mango ducha redondo de 3 posiciones.
Grifería de latón cromado.
Presión máximo 6 at. mínimo 1 at.
Caudal medio 12 l/min.
Distribuidor redondo de latón cromado.
Flexo reforzado 1,5 m
Cartucho cerámico Citecde 25 mm.

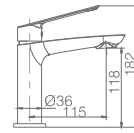

Ref.: **BDX023-1** Precio: **62 €**
IVA NO INCLUIDO

Monomando de lavabo.
Cuerpo de grifería en Latón cromado.
Cartucho cerámico Citec de 25 mm.
Flexos 3/8

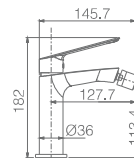

Ref.: **BDX023-2** Precio: **67 €**
IVA NO INCLUIDO

Monomando de bidé.
Cuerpo de grifería en Laton cromado.
Cartucho cerámico Citec de 25 mm.
Flexos 3/8

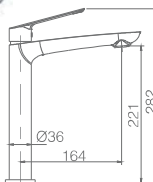

Ref.: **BDX023-3** Precio: **89 €**
IVA NO INCLUIDO

Monomando de lavabo.
Cuerpo de grifería en Latón cromado.
Cartucho cerámico Citec de 25 mm.
Flexos 3/8





LUXOR NEGRO MATE

SERIE



Modelos de líneas curvas y redondas que aportan al baño confort, elegancia y bienestar.





LUXOR
NEGRO MATE
SERIE





Ref.: BDX023/NG Precio: 199 €
IVA NO INCLUIDO

Barra de ducha extensible de acero inox. negro mate, extensible 95/133 cm.
Rociador de acero inox. redondo Ø20cm, extraplano, negro mate y antical.
Soporte teléfono regulable en altura.
Mango ducha redondo de 3 posiciones.
Grifería de latón negro mate.
Presión máximo 6 at. mínimo 1 at.
Caudal medio 12 l/min.
Distribuidor redondo de latón negro mate.
Flexo PVC negro mate 1,5 m
Cartucho cerámico Citec de 25 mm.





Ref.: BDX023-1NG Precio: 78 €
IVA NO INCLUIDO

Monomando de lavabo.
Cuerpo de grifería en Latón negro mate.
Cartucho cerámico Citec de 25 mm.
Flexos 3/8





Ref.: BDX023-2NG Precio: 83 €
IVA NO INCLUIDO

Monomando de bidé.
Cuerpo de grifería en Latón negro mate.
Cartucho cerámico Citec de 25 mm.
Flexos 3/8





Ref.: BDX023-3NG Precio: 103 €
IVA NO INCLUIDO

Monomando de lavabo.
Cuerpo de grifería en Latón negro mate.
Cartucho cerámico Citec de 25 mm.
Flexos 3/8





LUXOR BLANCO MATE

SERIE



LUXOR BLANCO MATE

SERIE





Ref.: **BDX023/BL** Precio: **199 €**
IVA NO INCLUIDO

Barra de ducha extensible de acero inox. blanco mate, extensible 95/133cm.
Rociador de acero inox. redondo Ø20cm, extraplano, negro mate y antical.
Soporte teléfono regulable en altura.
Mango ducha redondo de 3 posiciones.
Grifería de latón blanco mate.
Presión máximo 6 at. mínimo 1 at.
Caudal medio 12 l/min.
Distribuidor redondo de latón blanco mate.
Flexo PVC blanco mate 1,5 m
Cartucho cerámico Citec de 25 mm.



Ref.: **BDX023-1BL** Precio: **78 €**
IVA NO INCLUIDO

Monomando de lavabo.
Cuerpo de grifería en Latón blanco mate.
Cartucho cerámico Citec de 25 mm.
Flexos 3/8



Ref.: **BDX023-2BL** Precio: **83 €**
IVA NO INCLUIDO

Monomando de bidé.
Cuerpo de grifería en Latón blanco mate.
Cartucho cerámico Citec de 25 mm.
Flexos 3/8



Ref.: **BDX023-3BL** Precio: **103 €**
IVA NO INCLUIDO

Monomando de lavabo.
Cuerpo de grifería en Latón blanco mate.
Cartucho cerámico Citec de 25 mm.
Flexos 3/8







ELBA

CROMO / NEGRO

SERIE

ELBA

CROMO / NEGRO

SERIE





940-1300

Ref: BDA022/NG Precio: 175 €
IVA NO INCLUIDO

Barra de ducha extensible de acero inox. cromo, extensible 94/130cm.
Rociador de acero inox. redondo Ø20cm, extraplano, cromo y antical.
Soporte teléfono regulable en altura.
Mango ducha redondo de 3 posiciones.
Grifería de latón cromo / negro mate.
Presión máximo 6 at. mínimo 1 at.
Caudal medio 12 l/min.
Distribuidor redondo de latón cromo.
Flexo reforzado cromado 1,5 m
Cartucho cerámico de 35 mm.



8 410201 279624



Grifería con certificación



Ref: BDA022-1NG Precio: 67 €
IVA NO INCLUIDO

Monomando de lavabo.
Cuerpo de grifería en Latón cromo / negro mate.
Cartucho cerámico de 35 mm.
Flexos 3/8



8 410201 259626



Grifería con certificación



Ref: BDA022-2NG Precio: 66 €
IVA NO INCLUIDO

Monomando de bidé.
Cuerpo de grifería en Latón cromo / negro mate.
Cartucho cerámico de 35 mm.
Flexos 3/8



8 410201 260622



Grifería con certificación



Ref: BDA022-3NG Precio: 124 €
IVA NO INCLUIDO

Monomando de lavabo alto.
Cuerpo de grifería en Latón cromo / negro mate.
Cartucho cerámico de 35 mm.
Flexos 3/8



8 410201 261628



Grifería con certificación



ELBA

CROMO / BLANCO

SERIE



CR/BL

ELBA
CROMO / BLANCO
SERIE







940-1300

Ref.: BDA022/BL Precio: 175 €
IVA NO INCLUIDO

Barra de ducha extensible de acero inox. cromo, extensible 94/130cm.
Rociador de acero inox. redondo Ø20cm, extraplano, cromo y antical.
Soporte teléfono regulable en altura.
Mango ducha redondo de 3 posiciones.
Grifería de latón cromo / blanco.
Presión máximo 6 at. mínimo 1 at.
Caudal medio 12 l/min.
Distribuidor redondo de latón cromo.
Flexo reforzado 1,5 m
Cartucho cerámico de 35 mm.



8 410201 280620



Grifería con certificación



Ref.: BDA022-1BL Precio: 67 €
IVA NO INCLUIDO

Monomando de lavabo.
Cuerpo de grifería en Latón cromo / blanco.
Cartucho cerámico de 35 mm.
Flexos 3/8



8 410201 281627



Grifería con certificación



Ref.: BDA022-2BL Precio: 66 €
IVA NO INCLUIDO

Monomando de bidé.
Cuerpo de grifería en Latón cromo / blanco.
Cartucho cerámico de 35 mm.
Flexos 3/8



8 410201 282624



Grifería con certificación



Ref.: BDA022-3BL Precio: 124 €
IVA NO INCLUIDO

Monomando de lavabo alto.
Cuerpo de grifería en Latón cromo / blanco.
Cartucho cerámico de 35 mm.
Flexos 3/8



8 410201 283621



Grifería con certificación

MILAN

SERIE



Líneas suaves y redondas, una exquisitez para los sentidos, un conjunto polivalente que puede ser instalado en multitud de baños.









Ref.: BDM002 **Precio: 165 €**
IVA NO INCLUIDO

Barra de ducha extensible de acero inox. extensible 94/132cm.
Rociador de acero inox. redondo Ø20cm, extraplano, cromado y antical.
Soporte teléfono regulable en altura.
Mango ducha redondo.
Grifería de latón cromado.
Presión máximo 6 at. mínimo 1 at.
Caudal medio 12 l/min.
Distribuidor redondo de latón cromado.
Flexo reforzado 1,5 m
Cartucho monomando cerámico 35mm



Ref.: BDM002-1 **Precio: 58 €**
IVA NO INCLUIDO

Monomando de lavabo.
Cuerpo de grifería en Latón cromado.
Cartucho cerámico de 35 mm.
Flexos 3/8.

Ref.: BDM002-2 **Precio: 59 €**
IVA NO INCLUIDO

Monomando de bidé.
Cuerpo de grifería en Latón cromado.
Cartucho cerámico de 35 mm.
Flexos 3/8.



PARIS

SERIE



La evolución hacia el diseño y la exquisitez, con un marcado carácter.







Ref. : BDP004 **Precio : 189 €**
IVA NO INCLUIDO

Barra de ducha extensible de acero inox. extensible 94/132cm.
Rociador de acero inox. redondo Ø20 cm,extraplano,cromado y antical.
Soporte teléfono regulable en altura.
Mango ducha redondo 3 posiciones.
Grifería de latón cromado.
Presión máximo 6 at. mínimo 1 at.
Caudal medio 12 l/min.
Distribuidor redondo de latón cromado.
Flexo reforzado 1,5 m.
Cartucho monomando cerámico 35mm.



Ref. : BDP004-1 **Precio : 55 €**
IVA NO INCLUIDO

Monomando de lavabo.
Cuerpo de grifería en Latón cromado.
Cartucho cerámico de 35 mm.
Flexos 3/8.

Grifería con certificación
ACS **15 YEARS**

Ref. : BDP004-2 **Precio : 54 €**
IVA NO INCLUIDO

Monomando de bidé.
Cuerpo de grifería en Latón cromado.
Cartucho cerámico de 35 mm.
Flexos 3/8.

Grifería con certificación
ACS **15 YEARS**



SINTRA

SERIE



Una serie, en la que las líneas tradicionales han evolucionado para dar paso a una serie competitiva y sólida.



SINTRA

SERIE

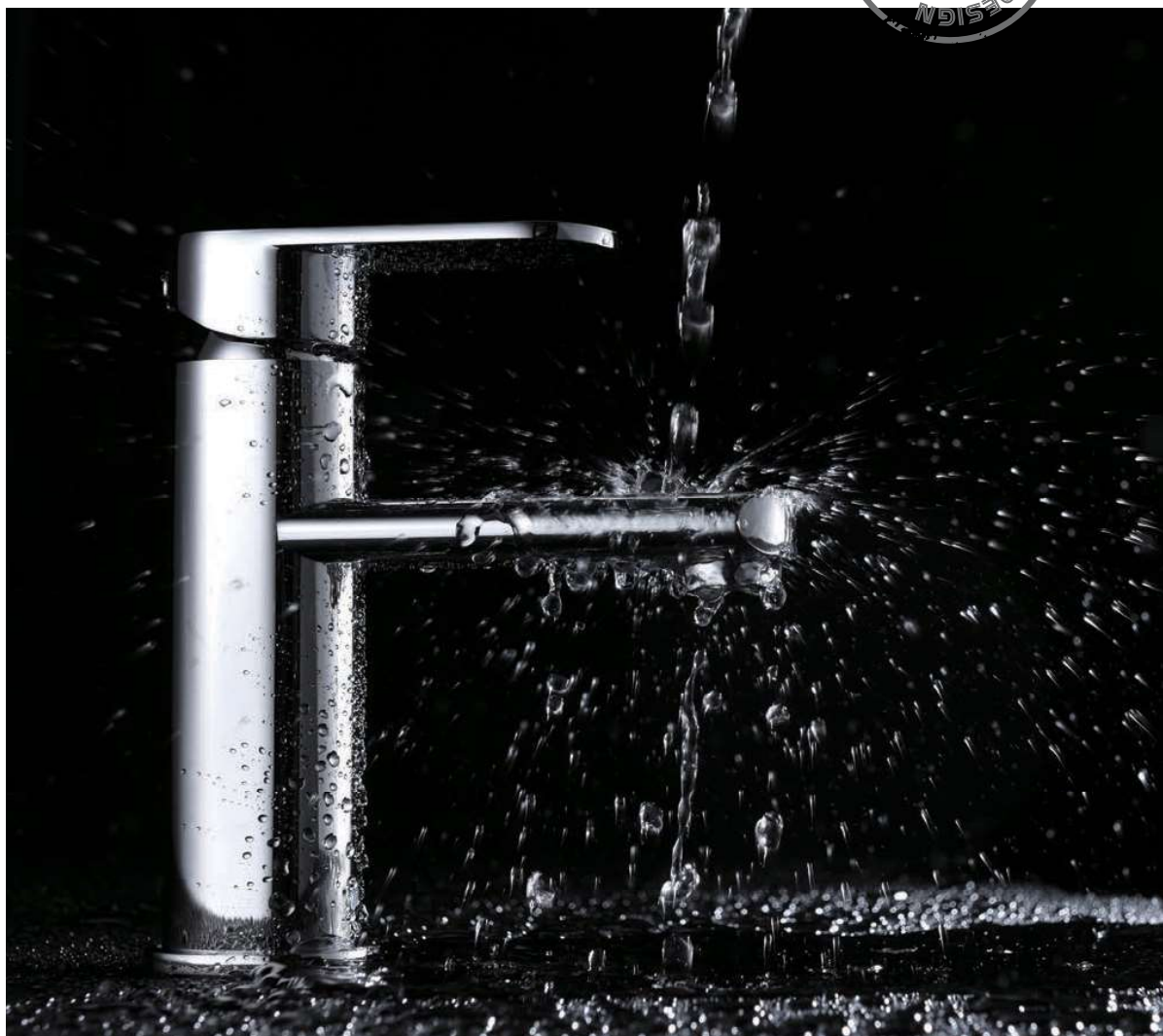



Ref: **BDS008** Precio: **149 €**
IVA NO INCLUIDO

Barra de ducha extensible de acero inox. extensible 94/132 cm.
Rociador de acero inox. redondo Ø20cm,extraplano,cromado y antical.
Soporte teléfono regulable en altura.
Mango ducha redondo 3 posiciones.
Grifería de latón cromado.
Presión máximo 6 at,mínimo 1 at.
Caudal medio 12 l/min.
Distribuidor redondo de latón cromado.
Flexo reforzado 1,5 m Cartucho monomando cerámico 35mm



Grifería con certificación

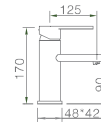

Ref: **BDS008-1** Precio: **55 €**
IVA NO INCLUIDO

Monomando de lavabo.
Cuerpo de grifería en Latón cromado.
Cartucho cerámico de 35 mm.
Flexos 3/8.



Grifería con certificación

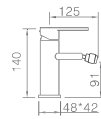

Ref: **BDS008-2** Precio: **56 €**
IVA NO INCLUIDO

Monomando de bidé.
Cuerpo de grifería en Latón cromado.
Cartucho cerámico de 35 mm.
Flexos 3/8.



Grifería con certificación

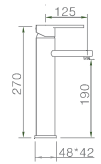

Ref: **BDS008-3** Precio: **89 €**
IVA NO INCLUIDO

Monomando de lavabo.
Cuerpo de grifería en Latón cromado.
Cartucho cerámico de 35 mm.
Flexos 3/8.





NASSAU

SERIE



Producto de nueva generación que introduce novedades en el diseño y en el concepto de uso, como es la incorporación del distribuidor en la grifería.







NASSAU

SERIE

NASSAU

SERIE



Ref.: **BDU014** Precio: **158 €**
IVA NO INCLUIDO

Barra de ducha extensible de acero inox. extensible 87/123cm.
Rociador de acero inox. redondo Ø20cm,extraplano,cromado y antical.
Soporte teléfono regulable en altura.
Mango ducha redondo de 3 posiciones.
Grifería de latón cromado.
Presión máximo 6 at,mínimo 1 at.
Caudal medio 12 l/min.
Distribuidor integrado en la grifería.
Flexo reforzado 1,5 m
Cartucho monomando cerámico de 35mm.

Ref.: **BDU014-1** Precio: **59 €**
IVA NO INCLUIDO

Monomando de lavabo.
Cuerpo de grifería en Latón cromado.
Cartucho cerámico de 35 mm.
Flexos 3/8.

Grifería con certificación

Ref.: **BDU014-2** Precio: **49 €**
IVA NO INCLUIDO

Monomando de bidé.
Cuerpo de grifería en Latón cromado.
Cartucho cerámico de 35 mm.
Flexos 3/8.

Grifería con certificación

Ref.: **BDU014-3** Precio: **105 €**
IVA NO INCLUIDO

Monomando de lavabo.
Cuerpo de grifería en Latón cromado.
Cartucho cerámico de 35 mm.
Flexos 3/8.

Grifería con certificación



MADRID

SERIE



Ref. : GDM001
Mango ducha redondo de 3 posiciones.
Barra de ducha de acero.
Grifería de latón cromado.
Presión máximo 6 at. mínimo 1 at.
Caudal medio 12 l/min.
Flexo reforzado 1,5 m.
Cartucho monomando cerámico de 35mm.

Precio : 119 €
IVA NO INCLUIDO

Grifería con certificación
 



9 780201 371024





MONOMANDO DE LAVABO

OLIMPO

SERIE





OLIMPO

SERIE



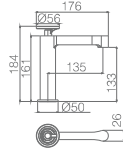

Ref.: **BDC033-1CR** Precio: **98 €**
IVA NO INCLUIDO

Monomando de lavabo.
Cuerpo de grifería en Latón cromado.
Cartucho cerámico de 25 mm.
Flexos 3/8.

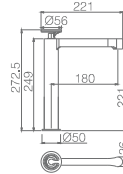

Ref.: **BDC033-3CR** Precio: **146 €**
IVA NO INCLUIDO

Monomando de lavabo alto.
Cuerpo de grifería en Latón cromado.
Cartucho cerámico de 25 mm.
Flexos 3/8.

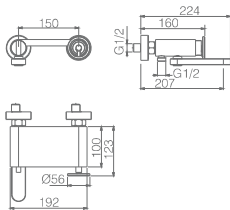

Ref.: **BDC033-4CR** Precio: **239 €**
IVA NO INCLUIDO

Grifería baño/ducha latón cromado.
Soporte para mango de ducha de ABS.
Mango ducha redondo.
Presión máximo 6 at. mínimo 1 at.
Caudal medio 12 l/min.
Flexo reforzado PVC 1,7m.
Cartucho monomando cerámico de 25mm.

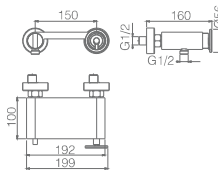

Ref.: **BDC033-5CR** Precio: **187 €**
IVA NO INCLUIDO

Grifería ducha latón cromado.
Soporte para mango de ducha de ABS.
Mango ducha redondo.
Presión máximo 6 at. mínimo 1 at.
Caudal medio 12 l/min.
Flexo reforzado PVC 1,7m.
Cartucho monomando cerámico de 25mm.



OLIMPO NEGRO ORO ROSA

SERIE

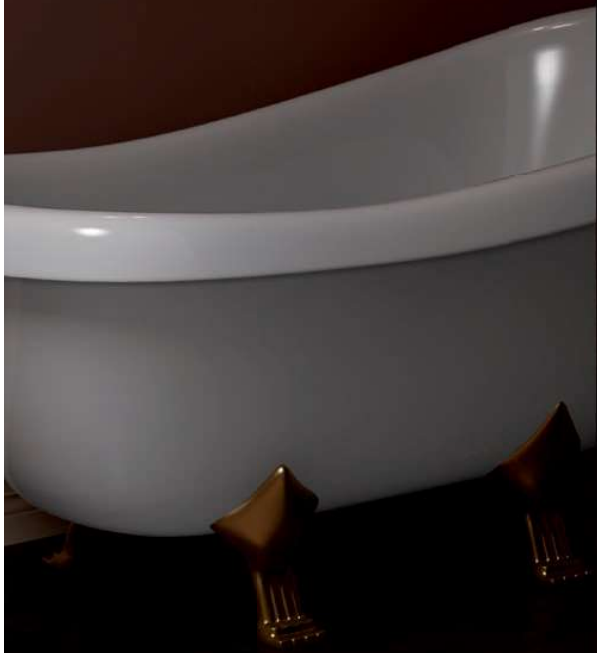



OLIMPO

SERIE



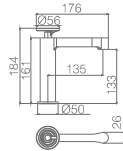

Ref.: **BDC033-1NOR** Precio: **109 €**
IVA NO INCLUIDO

Monomando de lavabo.
Cuerpo de grifería en Latón negro mate, oro rosa.
Cartucho cerámico de 25 mm.
Flexos 3/8.

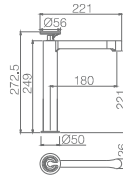

Ref.: **BDC033-3NOR** Precio: **163 €**
IVA NO INCLUIDO

Monomando de lavabo alto.
Cuerpo de grifería en Latón negro mate, oro rosa.
Cartucho cerámico de 25 mm.
Flexos 3/8.

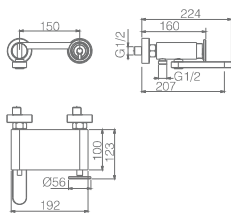

Ref.: **BDC033-4NOR** Precio: **269 €**
IVA NO INCLUIDO

Grifería baño/ducha latón negro mate, oro rosa.
Soporte para mango de ducha de ABS.
Mango ducha redondo.
Presión máximo 6 at. mínimo 1 at.
Caudal medio 12 l/min.
Flexo reforzado PVC 1,7 m.
Cartucho monomando cerámico de 25mm.

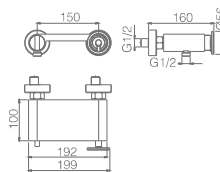

Ref.: **BDC033-5NOR** Precio: **229 €**
IVA NO INCLUIDO

Grifería ducha latón negro mate, oro rosa.
Soporte para mango de ducha de ABS.
Mango ducha redondo.
Presión máximo 6 at. mínimo 1 at.
Caudal medio 12 l/min.
Flexo reforzado PVC 1,7m.
Cartucho monomando cerámico de 25mm.



OLIMPO NEGRO MATE

SERIE





OLIMPO

SERIE



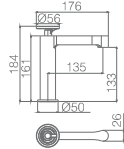

Ref.: **BDC033-1NG**

Precio: **108 €**
IVA NO INCLUIDO

Monomando de lavabo.
Cuerpo de grifería en Latón negro mate.
Cartucho cerámico de 25 mm.
Flexos 3/8.

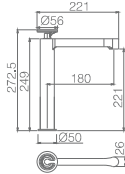

Ref.: **BDC033-3NG**

Precio: **160 €**
IVA NO INCLUIDO

Monomando de lavabo alto.
Cuerpo de grifería en Latón negro mate.
Cartucho cerámico de 25 mm.
Flexos 3/8.

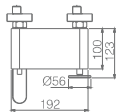
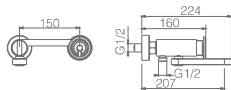

Ref.: **BDC033-4NG**

Precio: **259 €**
IVA NO INCLUIDO

Grifería baño/ducha latón negro mate.
Soporte para mango de ducha de ABS.
Mango ducha redondo.
Presión máximo 6 at. mínimo 1 at.
Caudal medio 12 l/min.
Flexo reforzado PVC 1,7 m.
Cartucho monomando cerámico de 25mm.

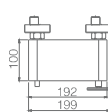
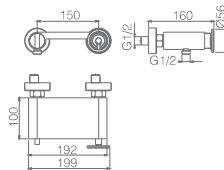

Ref.: **BDC033-5NG**

Precio: **204 €**
IVA NO INCLUIDO

Grifería ducha latón negro mate.
Soporte para mango de ducha de ABS.
Mango ducha redondo.
Presión máximo 6 at. mínimo 1 at.
Caudal medio 12 l/min.
Flexo reforzado PVC 1,7m.
Cartucho monomando cerámico de 25mm.





ACERO
S 316
INOX

MOSCU

SERIE

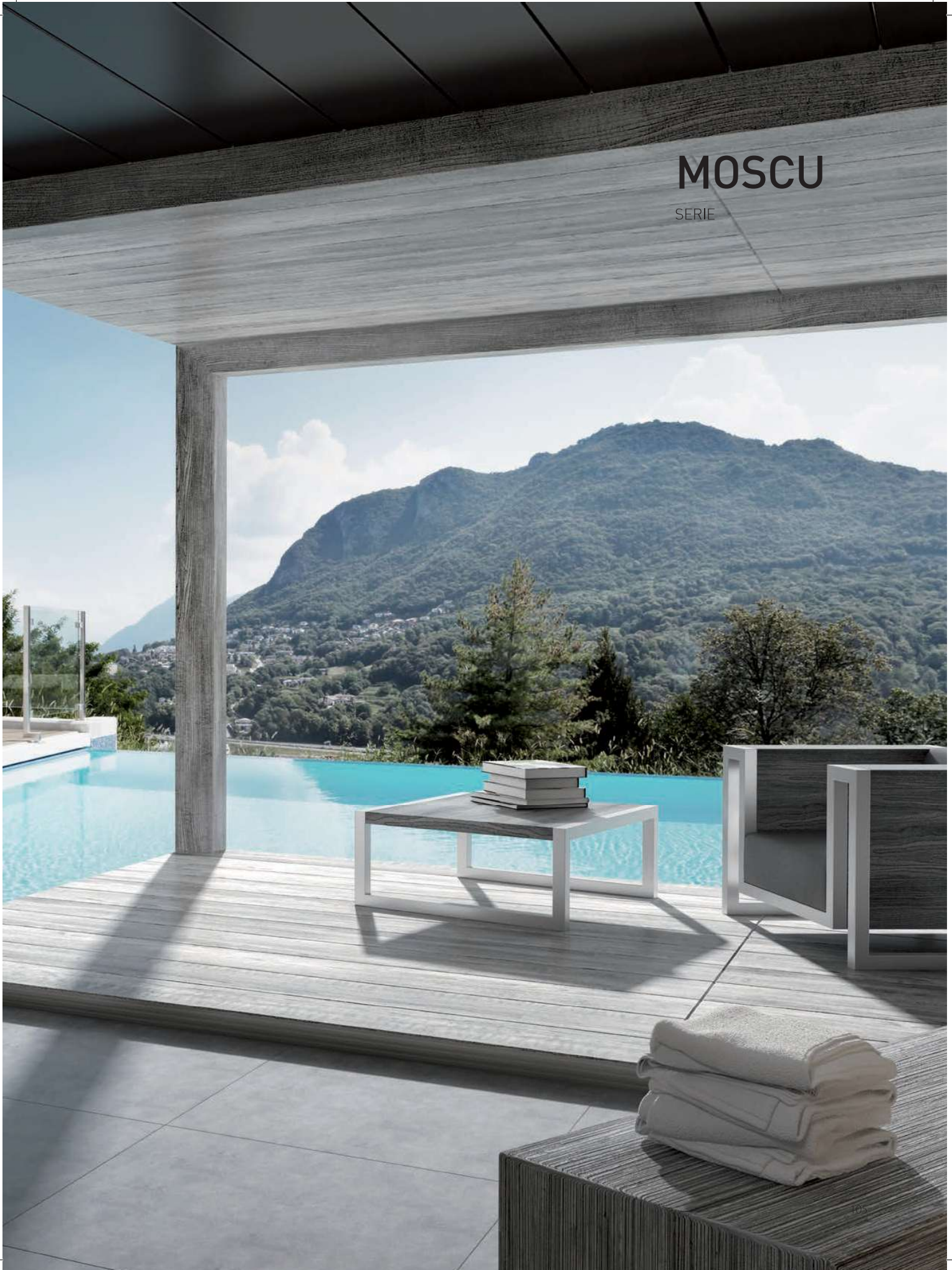

MOSCU

SERIE

10
AÑOS
GARANTÍA
ANTICORROSIÓN
ACERO INOX. S316



Válido tanto para interior como exterior alta resistencia



MOSCU

SERIE



Válido tanto para
interior como exterior.
Alta resistencia

10 AÑOS
GARANTÍA
ANTICORROSIÓN
ACERO INOX. S316



Ref.: **BDK034** Precio: **238 €**
IVA NO INCLUIDO

Barra de ducha de acero S316. extensible 98/140cm, máxima calidad anticorrosión y alta resistencia.
Rociador de acero S316. redondo Ø20cm, extraplano y antical.
Soporte teléfono regulable en altura.
Mango ducha redondo de 1 posición de acero S316.
Grifería de acero S316.
Presión máximo 6 at, mín 1 at.
Caudal medio 12 l/min.
Distribuidor integrado en la grifería de acero S316.
Flexo reforzado 1,5 mts de acero S316
Cartucho monomando cerámico de 35mm.
VALIDO TANTO PARA INTERIOR COMO PARA EXTERIOR



Ref.: **BDK034-1** Precio: **72 €**
IVA NO INCLUIDO

Monomando de lavabo.
Cuerpo de grifería en acero S316, máxima calidad anticorrosión y alta resistencia.
Cartucho cerámico de 25 mm.
Flexos 3/8.

Ref.: **BDK034-2** Precio: **74 €**
IVA NO INCLUIDO

Monomando de bidé.
Cuerpo de grifería en acero S316, máxima calidad anticorrosión y alta resistencia.
Cartucho cerámico de 25 mm.
Flexos 3/8.

CÓRCEGA

SERIE

Ref. : **BBECO1**

Grifería exenta de bañera en latón cromado.
Cartucho cerámico de 35 mm sedal.
Mango de ducha redondo.
Flexo de pvc.
Caja de registro a suelo.

Precio : **345 €**

IVA NO INCLUIDO

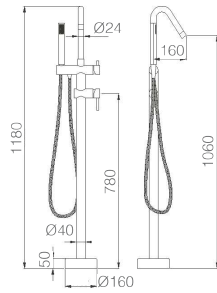





CÓRCEGA

NEGRO MATE

SERIE

Ref. : **BBECO1/NG**

Grifería exenta de bañera en latón negro mate.
Cartucho cerámico de 35 mm sedal.
Mango de ducha redondo.
Flexo de pvc.
Caja de registro a suelo.

Precio : **399 €**

IVA NO INCLUIDO

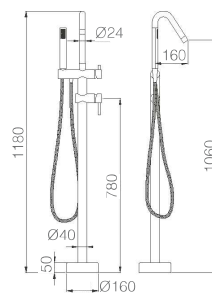



TEIDE

SERIE



TEIDE

SERIE







TEIDE

SERIE



Ref.: **BDT021** Precio: **139 €**
IVA NO INCLUIDO

Barra de ducha extensible de acero inox. extensible 94/130 cm.
Rociador de acero inox. redondo 20cm, extraplano, cromado y antical.
Soporte teléfono regulable en altura.
Mango ducha redondo.
Grifería de latón cromado.
Presión máximo 6 at. mínimo 1 at.
Caudal medio 12 l/min.
Distribuidor redondo de latón cromado.
Flexo reforzado 1,5 m
Cartucho monomando cerámico 35 mm.



Ref.: **BDT021-1** Precio: **51 €**
IVA NO INCLUIDO

Monomando de lavabo.
Cuerpo de grifería en Latón cromado.
Cartucho cerámico de 35 mm.
Flexos 3/8.



Ref.: **BDT021-2** Precio: **50 €**
IVA NO INCLUIDO

Monomando de bidé.
Cuerpo de grifería en Latón cromado.
Cartucho cerámico de 35 mm.
Flexos 3/8.



**GRIFERÍA
MONOMANDO
CUADRADA**

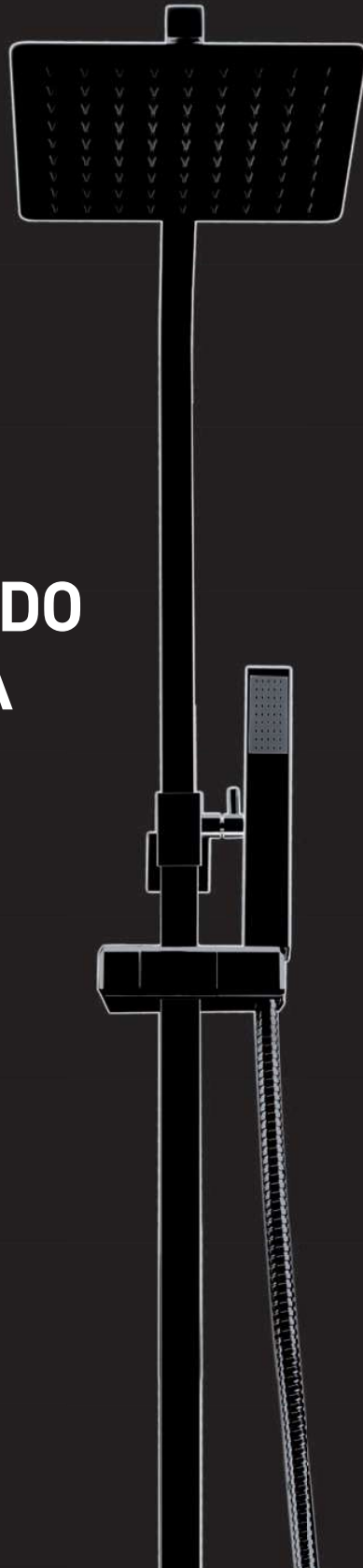

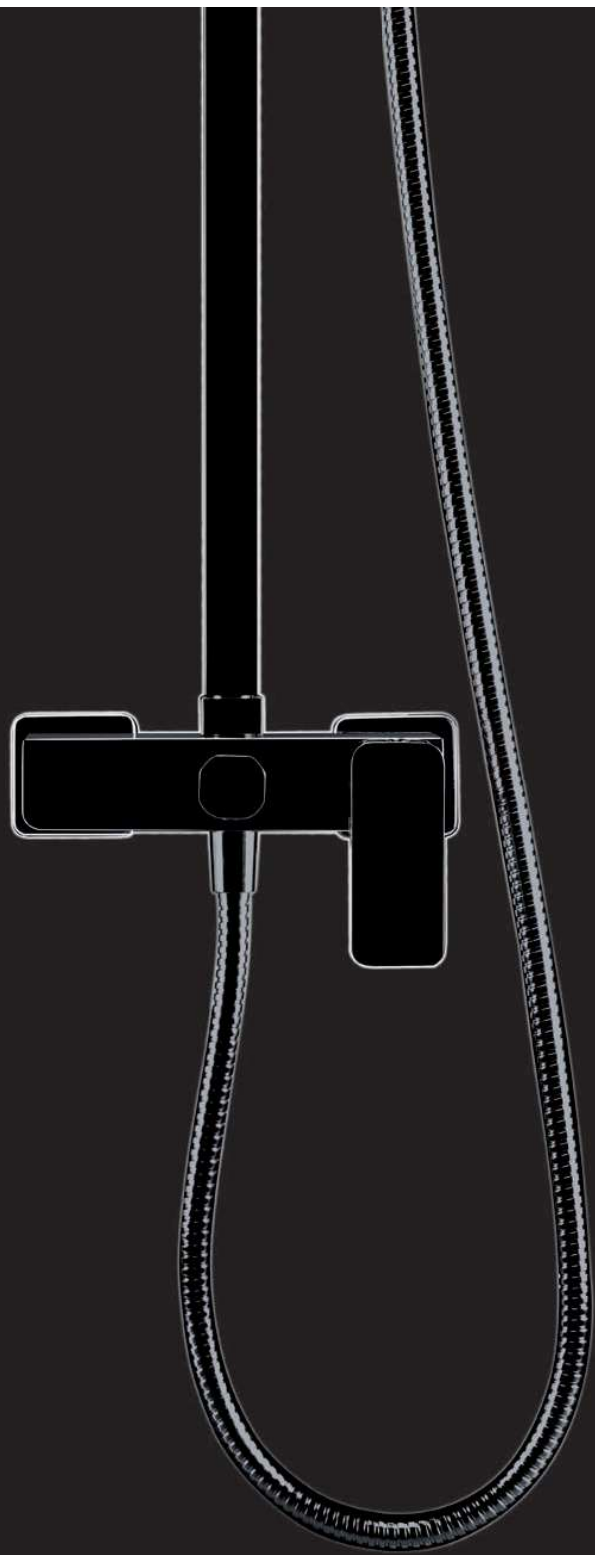

Nueva creación de IMEX de líneas curvas y apuradas con un pulido y un cromado excepcionales.



VALENCIA

SERIE



Modernidad y Calidez.
Modelo de diseño recto, cuadrado, con una gran versatilidad.





Serie de líneas rectas y cuadradas que proporcionan estilo y diseño en cualquier baño.



Ref.: **BDV003** Precio: **215 €**
IVA NO INCLUIDO

Barra de ducha extensible de acero inox. extensible 92/136 cm.
Rociador de acero inox. cuadrado 20cm, extraplano, cromado y antical.
Soporte teléfono regulable en altura.
Mango ducha cuadrado.
Grifería de latón cromado.
Presión máximo 6 at. mínimo 1 at.
Caudal medio 12 l/min.
Distribuidor cuadrado de latón cromado.
Flexo reforzado 1,5 m
Cartucho monomando cerámico 35 mm.



9 780201 379648

Grifería con certificación

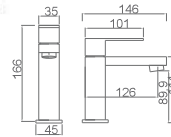
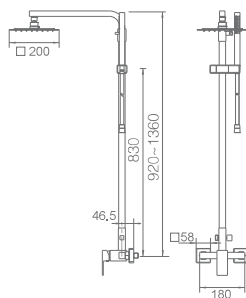

Ref.: **BDV003-1** Precio: **65 €**
IVA NO INCLUIDO

Monomando de lavabo.
Cuerpo de grifería en Latón cromado.
Cartucho cerámico de 25 mm.
Flexos 3/8.



9 780201 371123

Grifería con certificación

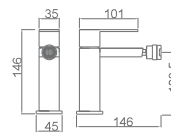

Ref.: **BDV003-2** Precio: **66 €**
IVA NO INCLUIDO

Monomando de bidé.
Cuerpo de grifería en Latón cromado.
Cartucho cerámico de 25 mm.
Flexos 3/8



9 780201 371222

Grifería con certificación

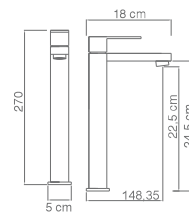

Ref.: **BDV003-3** Precio: **93 €**
IVA NO INCLUIDO

Monomando de lavabo.
Cuerpo de grifería en Latón cromado.
Cartucho cerámico de 25 mm.
Flexos 3/8



8 478023 772891





Ref.: **BDV003-4**

Grifería monomando de baño / ducha latón cromado.
 Soporte mango de ducha.
 Mango ducha cuadrado.
 Presión máximo 6 at, mínimo 1 at.
 Caudal medio 12 l/min.
 Flexo reforzado extensible 1,7 / 1,9 m
 Cartucho monomando cerámico de 35mm.

Precio: **119 €**

IVA NO INCLUIDO



Grifería con
certificación

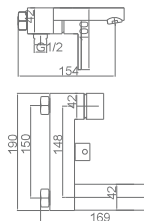

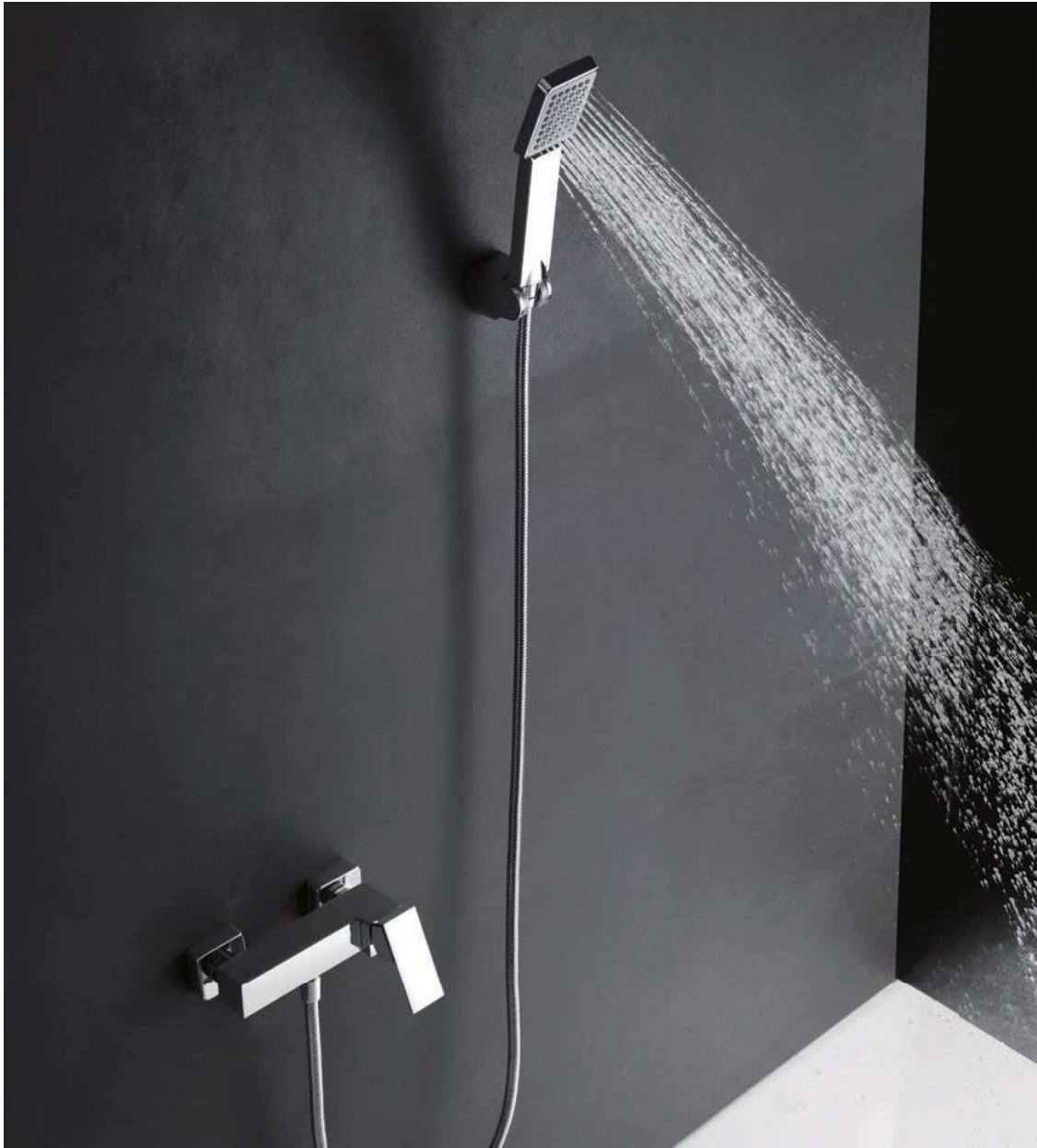

Ref.: **BDV003-5**

Grifería monomando de ducha latón cromado.
 Soporte mango de ducha.
 Mango ducha cuadrado.
 Presión máximo 6 at. mínimo 1 at.
 Caudal medio 12 l/min.
 Flexo reforzado extensible 1,7 /1,9 m
 Cartucho monomando cerámico de 35mm.

Precio: **95 €**
 IVA NO INCLUIDO



Grifería con
 certificación

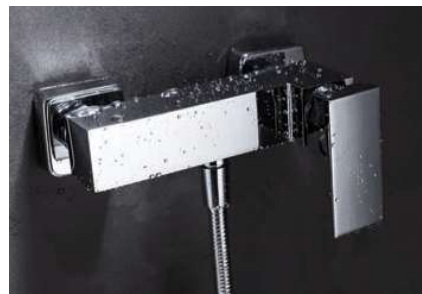
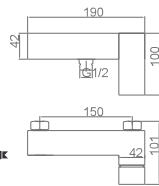

SUECIA

SERIE





SUECIA

SERIE



Serie de líneas rectas y cuadradas que proporcionan estilo y diseño en cualquier baño.



Ref.: **BDC032/CR** Precio: **235 €**
IVA NO INCLUIDO

Barra de ducha extensible de acero inox. 304, cromado, extensible 87/133 cm.
Rociador de acero inox. cuadrado 20cm, extraplano, cromado y antical.
Soporte teléfono regulable en altura.
Mango ducha cuadrado.
Grifería de latón cromado.
Presión máximo 6 at. mínimo 1 at.
Caudal medio 12 l/min.
Distribuidor cuadrado de latón cromado integrado en la grifería.
Flexo reforzado 1,5 m
Cartucho monomando cerámico 35 mm.

Ref.: **BDC032-1CR** Precio: **72 €**
IVA NO INCLUIDO

Monomando de lavabo.
Cuerpo de grifería en Latón cromado.
Cartucho cerámico de 25 mm.
Flexos 3/8.

Ref.: **BDC032-2CR** Precio: **68 €**
IVA NO INCLUIDO

Monomando de bidé.
Cuerpo de grifería en Latón cromado.
Cartucho cerámico de 25 mm.
Flexos 3/8

Ref.: **BDC032-3CR** Precio: **112 €**
IVA NO INCLUIDO

Monomando de lavabo alto.
Cuerpo de grifería en Latón cromado.
Cartucho cerámico de 25 mm.
Flexos 3/8



SUECIA NEGRO MATE

SERIE



SUECIA

SERIE





Ref.: **BDC032/NG** Precio: **249 €**
IVA NO INCLUIDO

Barra de ducha extensible de acero inox. negro mate extensible 87/133cm.
Rociador de acero inox. cuadrado 20cm, extraplano, negro mate y antical.
Soporte teléfono regulable en altura.
Mango ducha cuadrado.
Grifería de latón negro mate.
Presión máximo 6 at. mínimo 1 at.
Caudal medio 12 l/min.
Distribuidor cuadrado de latón negro mate, integrado en la grifería.
Flexo reforzado PVC 1,5 m
Cartucho monomando cerámico 35 mm.

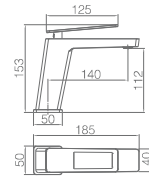

Ref.: **BDC032-1NG** Precio: **76 €**
IVA NO INCLUIDO

Monomando de lavabo.
Cuerpo de grifería en Latón negro mate.
Cartucho cerámico de 25 mm.
Flexos 3/8.

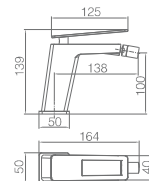

Ref.: **BDC032-2NG** Precio: **73 €**
IVA NO INCLUIDO

Monomando de bidé.
Cuerpo de grifería en Latón negro mate.
Cartucho cerámico de 25 mm.
Flexos 3/8

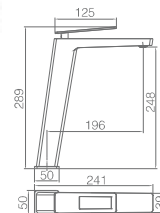

Ref.: **BDC032-3NG** Precio: **122 €**
IVA NO INCLUIDO

Monomando de lavabo alto.
Cuerpo de grifería en Latón negro mate.
Cartucho cerámico de 25 mm.
Flexos 3/8



SUECIA

NEGRO ORO ROSA

SERIE





SUECIA

SERIE



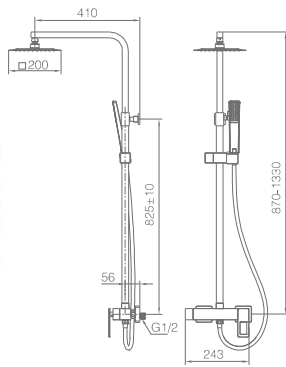

Ref.: **BDC032/NOR** Precio: **259 €**
IVA NO INCLUIDO

Barra de ducha de acero inox. negro mate, extensible 87/133 cm.
Rociador de acero inox. cuadrado 20cm, extraplano, oro rosa y antical.
Soporte teléfono regulable en altura.
Mango ducha cuadrado.
Grifería de latón negro, oro rosa.
Presión máximo 6 at. mínimo 1 at.
Caudal medio 12 l/min.
Distribuidor cuadrado de latón oro rosa, integrado en la grifería.
Flexo reforzado PVC 1,5 m
Cartucho monomando cerámico 35 mm.

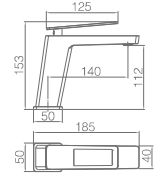

Ref.: **BDC032-1NOR** Precio: **84 €**
IVA NO INCLUIDO

Monomando de lavabo.
Cuerpo de grifería en Latón negro, oro rosa.
Cartucho cerámico de 25 mm.
Flexos 3/8

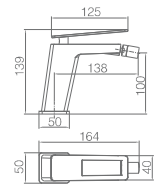

Ref.: **BDC032-2NOR** Precio: **78 €**
IVA NO INCLUIDO

Monomando de bidé.
Cuerpo de grifería en Latón negro, oro rosa.
Cartucho cerámico de 25 mm.
Flexos 3/8

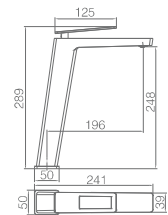

Ref.: **BDC032-3NOR** Precio: **127 €**
IVA NO INCLUIDO

Monomando de lavabo alto.
Cuerpo de grifería en Latón negro, oro rosa.
Cartucho cerámico de 25 mm.
Flexos 3/8



SUECIA

NEGRO ORO

SERIE





SUECIA

SERIE



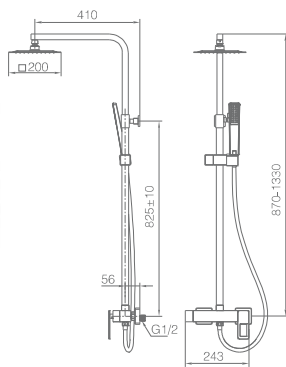

Ref.: **BDC032/NGOLD** Precio: **259 €**
IVA NO INCLUIDO

Barra de ducha de acero inox. negro mate, extensible 87/133 cm.
Rociador de acero inox. cuadrado 20cm, extraplano, oro brillo y antical.
Soporte teléfono regulable en altura.
Mango ducha cuadrado.
Grifería de latón negro, oro brillo.
Presión máximo 6 at. mínimo 1 at.
Caudal medio 12 l/min.
Distribuidor cuadrado de latón oro brillo, integrado en la grifería.
Flexo reforzado PVC 1,5 m
Cartucho monomando cerámico 35 mm.

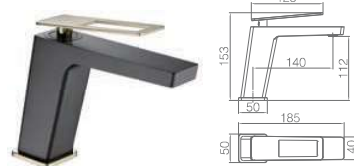

Ref.: **BDC032-1NGOLD** Precio: **84 €**
IVA NO INCLUIDO

Monomando de lavabo.
Cuerpo de grifería en Latón negro, oro brillo.
Cartucho cerámico de 25 mm.
Flexos 3/8

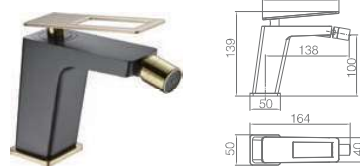

Ref.: **BDC032-2NGOLD** Precio: **80 €**
IVA NO INCLUIDO

Monomando de bidé.
Cuerpo de grifería en Latón negro, oro brillo.
Cartucho cerámico de 25 mm.
Flexos 3/8



Ref.: **BDC032-3NGOLD** Precio: **130 €**
IVA NO INCLUIDO

Monomando de lavabo alto.
Cuerpo de grifería en Latón negro, oro brillo.
Cartucho cerámico de 25 mm.
Flexos 3/8





ART

SERIE



ART

SERIE



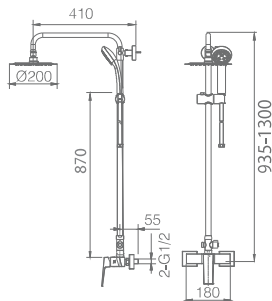

Ref.: **BDAR025** Precio: **145 €**
IVA NO INCLUIDO

Barra de ducha extensible de acero inox. extensible 93,5/130cm.
Rociador de acero inox. cuadrado 20cm,extraplano,cromado y antical.
Soporte teléfono regulable en altura.
Mango ducha cuadrado.
Grifería de latón cromado.
Presión máximo 6 at. mínimo 1 at.
Caudal medio 12 l/min.
Distribuidor redondo de latón cromado.
Flexo reforzado 1,5 m
Cartucho monomando cerámico 35 mm.

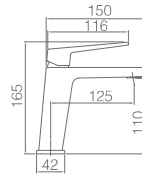

Ref.: **BDAR025-1** Precio: **65 €**
IVA NO INCLUIDO

Monomando de lavabo.
Cuerpo de grifería en Latón cromado.
Cartucho cerámico Citec de 25 mm.
Flexos 3/8.

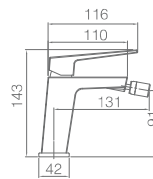

Ref.: **BDAR025-2** Precio: **66 €**
IVA NO INCLUIDO

Monomando de bidé.
Cuerpo de grifería en Laton cromado.
Cartucho cerámico Citec de 25 mm.
Flexos 3/8

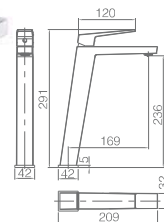

Ref.: **BDAR025-3** Precio: **104 €**
IVA NO INCLUIDO

Monomando de lavabo alto.
Cuerpo de grifería en Laton cromado.
Cartucho cerámico de 25 mm.
Flexos 3/8











ART BLANCO MATE

SERIE







Ref.: **BDAR025/BL** Precio: **178 €**
IVA NO INCLUIDO

Barra de ducha extensible de acero inox. blanco mate extensible 93,5/130cm.
Rociador de acero inox. cuadrado 20cm, extraplano, blanco mate y antical.
Soporte teléfono regulable en altura.
Mango ducha cuadrado.
Grifería de latón blanco mate.
Presión máximo 6 at. mínimo 1 at.
Caudal medio 12 l/min.
Distribuidor redondo de latón blanco mate.
Flexo reforzado 1,5 m
Cartucho monomando cerámico 35 mm.

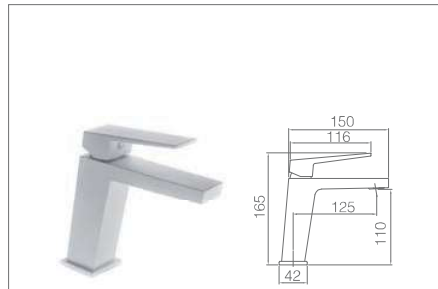

Ref.: **BDAR025-1BL** Precio: **71 €**
IVA NO INCLUIDO

Monomando de lavabo.
Cuerpo de grifería en Latón blanco mate.
Cartucho cerámico Citec de 25 mm.
Flexos 3/8.

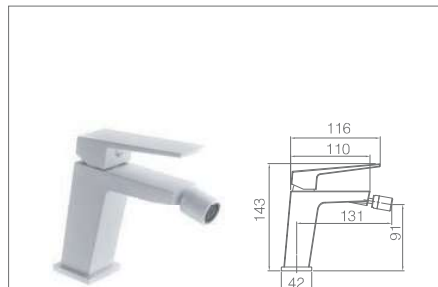

Ref.: **BDAR025-2BL** Precio: **71 €**
IVA NO INCLUIDO

Monomando de bidé.
Cuerpo de grifería en Latón blanco mate.
Cartucho cerámico Citec de 25 mm.
Flexos 3/8



Ref.: **BDAR025-3BL** Precio: **115 €**
IVA NO INCLUIDO

Monomando de lavabo alto.
Cuerpo de grifería en Latón blanco mate.
Cartucho cerámico de 25 mm.
Flexos 3/8



ART NEGRO MATE

SERIE









Ref.: **BDAR025/NG** Precio: **178 €**
IVA NO INCLUIDO

Barra de ducha extensible de acero inox. negro mate extensible 93,5/130cm.
Rociador de acero inox. cuadrado 20cm, extraplano, negro mate y antical.
Soporte teléfono regulable en altura.
Mango ducha cuadrado.
Grifería de latón negro mate.
Presión máximo 6 at. mínimo 1 at.
Caudal medio 12 l/min.
Distribuidor redondo de latón negro mate.
Flexo reforzado 1,5 m
Cartucho monomando cerámico 35 mm.

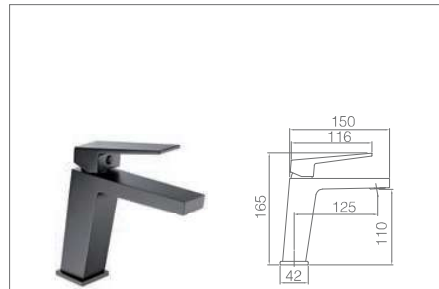

Ref.: **BDAR025-1NG** Precio: **71 €**
IVA NO INCLUIDO

Monomando de lavabo.
Cuerpo de grifería en Latón negro mate.
Cartucho cerámico Citec de 25 mm.
Flexos 3/8.

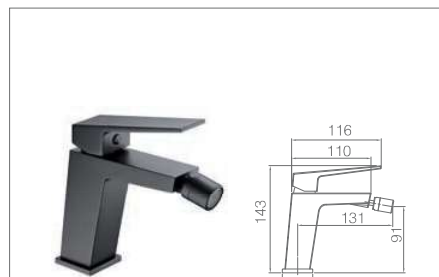

Ref.: **BDAR025-2NG** Precio: **71 €**
IVA NO INCLUIDO

Monomando de bidé.
Cuerpo de grifería en Latón negro mate.
Cartucho cerámico Citec de 25 mm.
Flexos 3/8



Ref.: **BDAR025-3NG** Precio: **115 €**
IVA NO INCLUIDO

Monomando de lavabo alto.
Cuerpo de grifería en Latón negro mate.
Cartucho cerámico de 25 mm.
Flexos 3/8





BREMEN

SERIE



De estructura moderna y voluminosa.

Un producto único, diseñado por nosotros en el que resalta la calidad y la funcionalidad.





Ref. : BDB006 **Precio : 240 €**
IVA NO INCLUIDO

Barra de ducha extensible de acero inox. extensible 87,5/130cm.
Rociador de acero inox. cuadrado 20cm,extraplano,cromado y antical.
Soporte teléfono regulable en altura.
Mango ducha cuadrado.
Grifería de latón cromado.
Presión máximo 6 at. mínimo 1 at.
Caudal medio 12 l/min.
Distribuidor cuadrado de latón cromado integrado.
Flexo reforzado 1,5 m
Cartucho monomando cerámico 35 mm.

9 780201 371321

Grifería con certificación
ACS **15 YEARS**

BREMEN

SERIE

Ref. : BDB006-1 **Precio : 69 €**
IVA NO INCLUIDO

Monomando de lavabo.
Cuerpo de grifería en Latón cromado.
Cartucho cerámico de 35 mm.
Flexos 3/8.

9 780201 371420

Grifería con certificación
ACS **15 YEARS**

Ref. : BDB006-2 **Precio : 61 €**
IVA NO INCLUIDO

Monomando de bidé.
Cuerpo de grifería en Latón cromado.
Cartucho cerámico de 35 mm.
Flexos 3/8.

9 780201 371529

Grifería con certificación
ACS **15 YEARS**



LIVERPOOL

SERIE



LA DUCHA, MÁS SENTIDO QUE NUNCA.

Cuando el sentido se transforma en algo esencial para tu vida, cuando sientes el estilo como algo propio y personal. Líneas estilizadas y únicas para tu hogar.





Barra de ducha extensible de acero inox. extensible 86/120 cm. Opción ducha.
 Barra de bañera extensible de acero inox. extensible 102-165 cm. Opción bañera.
 Rociador de acero inox. cuadrado 20cm,extraplano,cromado y antical.
 Soporte teléfono regulable en altura.
 Mango ducha cuadrado.
 Grifería de latón cromado.
 Presión máximo 6 at. mínimo 1 at.
 Caudal medio 12 l/min.
 Distribuidor cuadrado de latón cromado integrado.
 Flexo reforzado 1,5 m
 Cartucho monomando cerámico 35 mm.

Grifería con certificación
 ACS 5 YEARS

Ref. : BDB007-B **Ref. : BDB007**
 (opción bañera) (opción ducha)

Precio : 249 € **Precio : 229 €**
 IVA NO INCLUIDO IVA NO INCLUIDO

9 780201 371628

8 410201 203629

LIVERPOOL

SERIE

Ref. : BDL007-1 **Precio : 55 €**
 IVA NO INCLUIDO

Monomando de lavabo.
 Cuerpo de grifería en Latón cromado.
 Cartucho cerámico de 35 mm.
 Flexos 3/8.

9 780201 371826

Grifería con certificación
 ACS 5 YEARS

Ref. : BDL007-2 **Precio : 56 €**
 IVA NO INCLUIDO

Monomando de bide.
 Cuerpo de grifería en Laton cromado.
 Cartucho cerámico de 35 mm.
 Flexos 3/8.

9 780201 371925

Grifería con certificación
 ACS 5 YEARS





SAONA

SERIE

El diseño y la tecnología aunados para dar sentido a un modelo exquisito, con unas formas únicas e irrepetibles que enamoran a simple vista.

SAONA

SERIE



EXCELENTE, PRÁCTICO Y ORIGINAL.



Ref.: BDO020

Barra de bañera extensible de acero inox. extensible 101/163,5 cm.
 Rociador de acero inox. cuadrado 20cm,extraplano,cromado y antical.
 Soporte teléfono regulable en altura.
 Mango ducha cuadrado.
 Grifería de latón cromado.
 Presión máximo 6 at. mínimo 1 at.
 Caudal medio 12 l/min.
 Distribuidor cuadrado de latón cromado integrado de 3 vías.
 Flexo reforzado 1,5 m
 Cartucho monomando cerámico 35 mm.

Precio: 249 €
 IVA NO INCLUIDO

SISTEMA DE AHORRO ENERGÉTICO

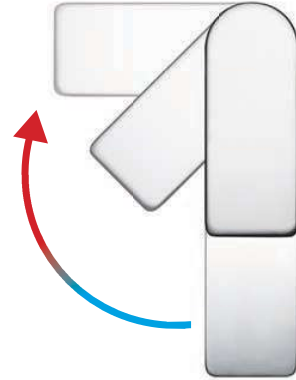

Ref.: BDO020-1 **Precio: 55 €**
 IVA NO INCLUIDO

Monomando de lavabo.
 Cuerpo de grifería en Latón cromado.
 Cartucho cerámico de 35 mm.
 Apertura en frío.
 Flexos 3/8.

Ref.: BDO020-2 **Precio: 54 €**
 IVA NO INCLUIDO

Monomando de bidé.
 Cuerpo de grifería en Latón cromado.
 Cartucho cerámico de 35 mm.
 Apertura en frío.
 Flexos 3/8.



BRISTOL

SERIE



Esencia y pureza se hacen realidad.



BRISTOL

SERIE



Ref. : BDB008 **Precio : 249 €**
IVA NO INCLUIDO

Barra de bañera extensible de acero inox. extensible 100/162 cm.
Rociador de acero inox. cuadrado 20cm,extraplano,cromado y antical.
Soporte teléfono regulable en altura.
Mango ducha redondo.
Grifería de latón cromado con caño de bañera plegable.
Presión máximo 6 at. mínimo 1 at.
Caudal medio 12 l/min.
Distribuidor cuadrado de latón cromado integrado.
Flexo reforzado 1,5 m
Cartucho monomando cerámico 35 mm.

Grifería con certificación
ACS
15 YEARS

9 780201 372021



Ref. : BDB008-1 **Precio : 55 €**
IVA NO INCLUIDO

Monomando de lavabo.
Cuerpo de grifería en Latón cromado.
Cartucho cerámico de 35 mm.
Flexos 3/8.

Grifería con certificación
ACS
15 YEARS

9 780201 372120

Ref. : BDB008-2 **Precio : 54 €**
IVA NO INCLUIDO

Monomando de bide.
Cuerpo de grifería en Latón cromado.
Cartucho cerámico de 35 mm.
Flexos 3/8.

Grifería con certificación
ACS
15 YEARS

9 780201 372228



NANTES

SERIE



NANTES

SERIE



Producto desarrollado a partir de lingotes de latón fundidos.
Grifería caracterizada por su calidad y presencia.

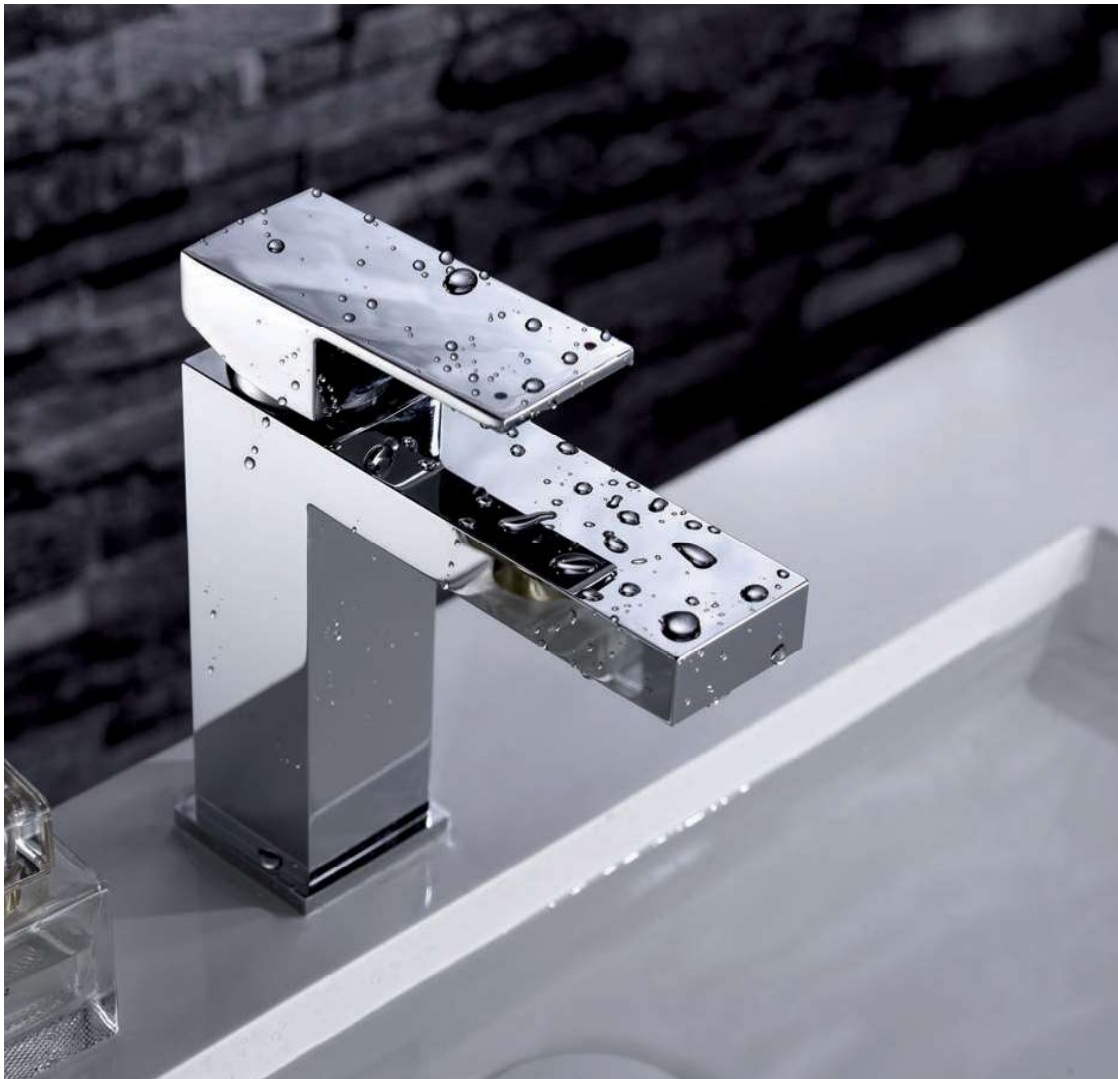



Ref. : BDN009 **Precio : 239 €**
IVA NO INCLUIDO

Barra de ducha extensible de acero inox. extensible 93/135 cm.
Rociador de acero inox. cuadrado 20cm, extraplano, cromado y antical.
Soporte teléfono regulable en altura.
Mango ducha cuadrado.
Grifería de latón cromado.
Presión máximo 6 at. mínimo 1 at.
Caudal medio 12 l/min.
Distribuidor cuadrado de latón cromado.
Flexo reforzado 1,5 m
Cartucho monomando cerámico 35 mm.

Grifería con certificación ACS 5 YEARS WARRANTY

9 780201 372328



Ref. : BDN009-1 **Precio : 66 €**
IVA NO INCLUIDO

Monomando de lavabo.
Cuerpo de grifería en Latón cromado.
Cartucho cerámico de 35 mm.
Flexos 3/8.

9 780201 372427

5 YEARS WARRANTY



Ref. : BDN009-2 **Precio : 67 €**
IVA NO INCLUIDO

Monomando de bide.
Cuerpo de grifería en Latón cromado.
Cartucho cerámico de 35 mm.
Flexos 3/8.

9 780201 372526

5 YEARS WARRANTY



Ref. : BDN009-3 **Precio : 99 €**
IVA NO INCLUIDO

Monomando de lavabo.
Cuerpo de grifería en Latón cromado.
Cartucho cerámico de 35 mm.
Flexos 3/8.

8 478023 772921

5 YEARS WARRANTY



FIYI

SERIE



La elegancia llevada a su máxima expresión. Integración en estado puro de todos sus elementos que hacen de esta serie una de las más atractivas de nuestra colección.



FIYI

SERIE



Ref.: BDF016 **Precio: 239 €**
IVA NO INCLUIDO

Barra de ducha extensible de acero inox. extensible 87/131 cm.
Rociador de acero inox. cuadrado 20cm, extraplano, cromado y antical.
Soporte teléfono regulable en altura.
Mango ducha cuadrado.
Grifería de latón cromado.
Presión máximo 6 at. mínimo 1 at.
Caudal medio 12 l/min.
Distribuidor cuadrado de latón cromado integrado.
Flexo reforzado 1,5 m
Cartucho monomando cerámico 35 mm.

Ref.: BDF016-1 **Precio: 68 €**
IVA NO INCLUIDO

Monomando de lavabo.
Cuerpo de grifería en Latón cromado.
Cartucho cerámico Citec de 25 mm.
Flexos 3/8

Ref.: BDF016-2 **Precio: 67 €**
IVA NO INCLUIDO

Monomando de bidé.
Cuerpo de grifería en Latón cromado.
Cartucho cerámico Citec de 25 mm.
Flexos 3/8

Ref.: BDF016-3 **Precio: 99 €**
IVA NO INCLUIDO

Monomando de lavabo alto.
Cuerpo de grifería en Latón cromado.
Cartucho cerámico Citec de 25 mm.
Flexos 3/8

Ref.: BDF016-5 **Precio: 115 €**
(+8 cm altura) IVA NO INCLUIDO





Ref.: BDF016-4

Grifería baño/ducha latón cromado.
 Soporte para mango de ducha de ABS.
 Mango ducha cuadrado.
 Presión máximo 6 at. mínimo 1 at.
 Caudal medio 12 l/min.
 Flexo reforzado extensible 1,7/1,9
 Cartucho monomando cerámico de 25mm.

Precio: 122 €
 IVA NO INCLUIDO

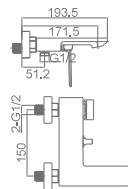

FIYI

SERIE

Ref.: **BDF016-4NG**

Grifería baño/ducha latón negro mate.
Soporte para mango de ducha de ABS.
Mango ducha cuadrado negro mate.
Presión máximo 6 at. mínimo 1 at.
Caudal medio 12 l/min.
Flexo reforzado PVC negro mate 1,7 m.
Cartucho monomando cerámico de 25mm.

Precio: **153 €**
IVA NO INCLUIDO

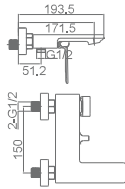







FIYI
NEGRO MATE

SERIE



FIYI NEGRO MATE

SERIE



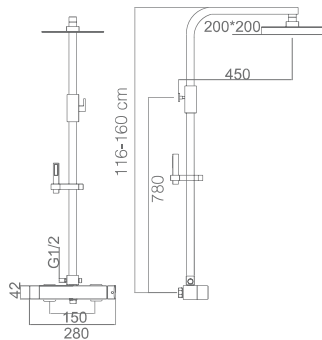

Ref.: **BDF016-B/NG** Precio: **298 €**
IVA NO INCLUIDO

Barra de bañera extensible de acero inox negro mate caño de bañera plegable.
Barra extensible 116/160 cm.
Rociador de acero inox. cuadrado 20cm, extraplano, negro y antical.
Soporte teléfono regulable en altura.
Mango ducha cuadrado negro mate.
Grifería de latón negro.
Presión máxima 6 at. mínimo 1 at.
Caudal medio 12 l/min.
Distribuidor cuadrado de latón negro integrado.
Flexo PVC negro mate 1,5 m
Carlucho monomando cerámico 35 mm.





Ref.: BDF016/NG **Precio : 255 €**
IVA NO INCLUIDO

Barra de ducha extensible de acero inox negro mate extensible 87/131 cm.
Rociador de acero inox. cuadrado 20cm, extraplano, negro y antical.
Soporte teléfono regulable en altura.
Mango ducha cuadrado negro mate.
Grifería de latón negro.
Presión máximo 6 at. mínimo 1 at.
Caudal medio 12 l/min.
Distribuidor cuadrado de latón negro integrado.
Flexo reforzado PVC negro mate 1,5 m
Cartucho monomando cerámico 35 mm.

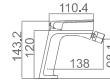

Ref.: BDF016-1NG **Precio : 74 €**
IVA NO INCLUIDO

Monomando de lavabo.
Cuerpo de grifería en Latón negro.
Cartucho cerámico Citec de 25 mm.
Flexos 3/8

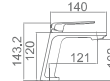

Ref.: BDF016-2NG **Precio : 74 €**
IVA NO INCLUIDO

Monomando de bidé.
Cuerpo de grifería en Latón negro.
Cartucho cerámico Citec de 25 mm.
Flexos 3/8

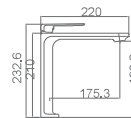

Monomando de lavabo alto.
Cuerpo de grifería en Latón negro.
Cartucho cerámico Citec de 25 mm.
Flexos 3/8

Ref.: BDF016-3NG **Precio : 115 €**
IVA NO INCLUIDO



Ref.: BDF016-5NG **Precio : 135 €**
(+8 cm altura)
IVA NO INCLUIDO







FIYI
BLANCO MATE
SERIE



FIYI
BLANCO MATE
SERIE



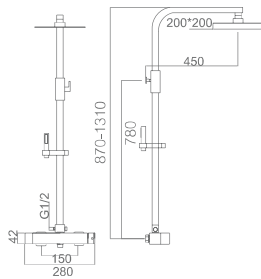

Ref. : BDF016/BL Precio : **255 €**
IVA NO INCLUIDO

Barra de ducha extensible de acero inox blanco mate extensible 87/131 cm.
Rociador de acero inox. cuadrado 20cm, extraplano, blanco y antical.
Soporte teléfono regulable en altura.
Mango ducha cuadrado blanco mate.
Grifería de latón blanco mate.
Presión máxima 6 at. mínimo 1 at.
Caudal medio 12 l/min.
Distribuidor cuadrado de latón blanco integrado.
Flexo reforzado PVC blanco mate 1,5 m
Cartucho monomando cerámico 35 mm.

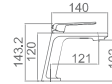

Ref. : BDF016-1BL Precio : **73 €**
IVA NO INCLUIDO

Monomando de lavabo.
Cuerpo de grifería en Latón blanco mate.
Cartucho cerámico Citec de 25 mm.
Flexos 3/8

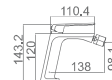

Ref. : BDF016-2BL Precio : **73 €**
IVA NO INCLUIDO

Monomando de bidé.
Cuerpo de grifería en Latón blanco mate.
Cartucho cerámico Citec de 25 mm.
Flexos 3/8

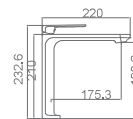

Monomando de lavabo alto.
Cuerpo de grifería en Latón blanco mate.
Cartucho cerámico Citec de 25 mm.
Flexos 3/8

Ref. : BDF016-3BL Precio : **114 €**
IVA NO INCLUIDO



Ref. : BDF016-5BL Precio : **135 €**
(+8 cm altura) IVA NO INCLUIDO





BALI

SERIE



Conjunción de componentes cuadrados con líneas curvas que hacen de este producto uno de los más competitivos de nuestra marca.





BALI

SERIE



Ref.: **BDI017** Precio: **145 €**
IVA NO INCLUIDO

Barra de ducha extensible de acero inox. extensible 94/130 cm.
Rociador de acero inox. cuadrado 20cm, extraplano, cromado y antical.
Soporte teléfono regulable en altura.
Mango ducha cuadrado.
Grifería de latón cromado.
Presión máximo 6 at. mínimo 1 at.
Caudal medio 12 l/min.
Distribuidor redondo de latón cromado.
Flexo reforzado 1,5 m
Cartucho monomando cerámico 35 mm.



Test de la grifería aprobado



Ref.: **BDI017-1** Precio: **57 €**
IVA NO INCLUIDO

Monomando de lavabo.
Cuerpo de grifería en Latón cromado.
Cartucho cerámico de 35 mm.
Flexos 3/8.



Test de la grifería aprobado



Ref.: **BDI017-2** Precio: **53 €**
IVA NO INCLUIDO

Monomando de bidé.
Cuerpo de grifería en Latón cromado.
Cartucho cerámico de 35 mm.
Flexos 3/8.



Test de la grifería aprobado

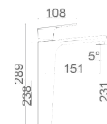

Ref.: **BDI017-3** Precio: **92 €**
IVA NO INCLUIDO

Monomando de lavabo alto.
Cuerpo de grifería en Latón cromado.
Cartucho cerámico de 35 mm.
Flexos 3/8.



Test de la grifería aprobado





BALI

SERIE



Ref.: **BDI017-4**

Grifería baño/ducha de latón cromado.
 Soporte para mango de ducha en ABS.
 Mango ducha cuadrado.
 Presión máximo 6 at, mínimo 1 at.
 Caudal medio 12 l/min.
 Flexo reforzado extensible de 1,7/1,9 m
 Cartucho monomando cerámico 35mm.

Precio: 88 €
 IVA NO INCLUIDO



Test de la grifería
 aprobado

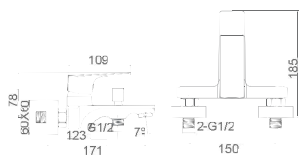

Ref.: **BDI017-5**

Grifería ducha de latón cromado.
 Soporte para mango de ducha en ABS.
 Mango ducha cuadrado.
 Presión máximo 6 at, mínimo 1 at.
 Caudal medio 12 l/min.
 Flexo reforzado extensible de 1,7/1,9 m
 Cartucho monomando cerámico 35mm.

Precio: 69 €
 IVA NO INCLUIDO



Test de la grifería
 aprobado

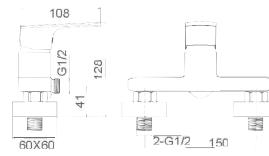



EUROPA

SERIE



Ref.: **BDE011** Precio: **95 €** (grifería no incluida)
IVA NO INCLUIDO

Barra de ducha de acero inox. 97 cm.
Rociador de acero inox. redondo 20cm, extraplano, cromado y antical.
Soporte teléfono regulable en altura.
Mango ducha redondo.
Presión máximo 6 at. mínimo 1 at.
Caudal medio 12 l/min.
Distribuidor redondo de latón cromado.
Flexo reforzado 1,5 m
Flexo de conexión a grifería reforzado de 60 cm



MINSK

SERIE



Ref.: **BDK010** Precio: **129 €** (grifería no incluida)
IVA NO INCLUIDO

Barra de ducha de acero inox. extensible 93/133 cm.
Rociador de acero inox. cuadrado 20cm, extraplano, cromado y antical.
Soporte teléfono regulable en altura.
Mango ducha cuadrado.
Presión máximo 6 at. mínimo 1 at.
Caudal medio 12 l/min.
Distribuidor cuadrado de latón cromado.
Flexo reforzado 1,5 m
Flexo de conexión a grifería reforzado de 60 cm





GRIFERÍA TERMOSTÁTICA

Griferías termostáticas de nueva generación con cartuchos contruídos de polímero que les confieren una especial resistencia al agua de tipo medio y duro



DUCHA TERMOSTÁTICA DE TECNOLOGÍA DE ÚLTIMA GENERACIÓN

IMEX
BATH EQUIPMENTS



RE-EVOLUCIÓN



Vídeo
spot



Vídeo
técnico
profesional



38°C

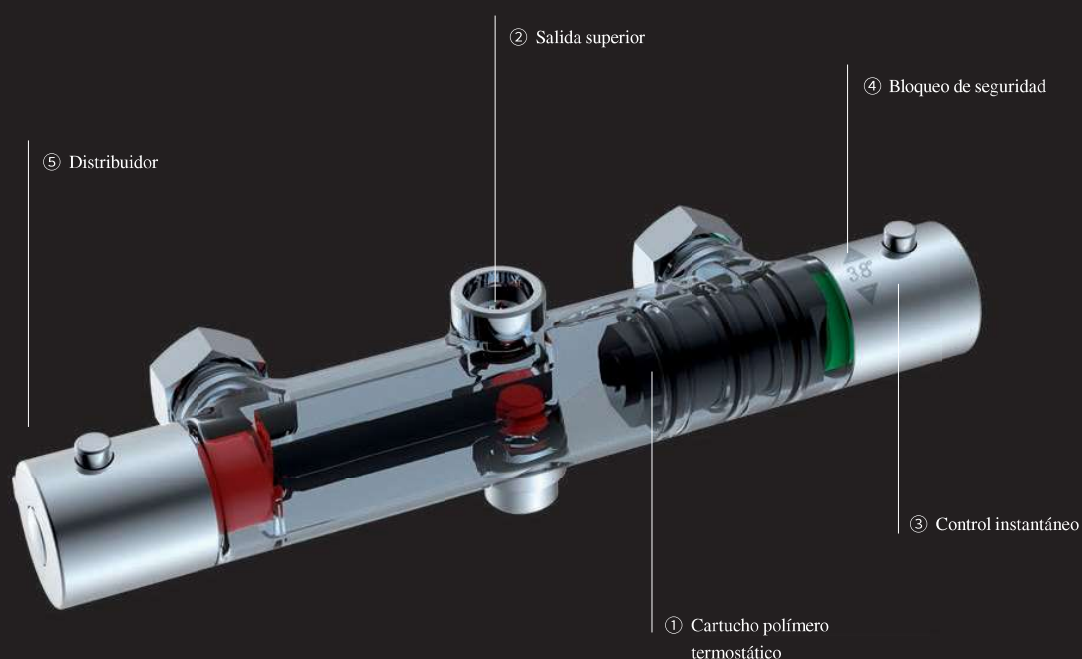

① Con el cartucho termostático avanzado, el flujo de agua y la temperatura se pueden controlar de manera exacta y opcionalmente .

② Para mejorar la sensibilidad de los accesorios termostáticos, la salida superior permanece constante y en la presión de agua baja y alta .

③ Controle exactamente el agua a la temperatura adecuada en un instante, para evitar el desperdicio de la temperatura o la presión del agua que cambia, proporcionando una sensación constante y cómoda durante el baño.

④ El bloqueo de seguridad debe ser presionado para obtener una temperatura >38°C, para evitar quemaduras.

⑤ El distribuidor integrado permite seleccionar la salida del agua en una dirección u otra.



NOVEDAD

GRIFERÍA TERMOSTÁTICA CON
TECNOLOGÍA DE ÚLTIMA GENERACIÓN
Sistema de giro y limpieza Turn Clean System
(Sistema patentado)

KENT

SERIE

Grifería termostática TURN CLEAN SYSTEM (patentado), equipada con tecnología de última generación.

- Sistema de seguridad anti-scalding.
- Funcionamiento óptimo en condiciones de baja presión.
- Limpieza de cartucho fácil, rápido y eficaz.

Vídeo spot



Vídeo técnico profesional



Ref. : **BTK017**

- Cartucho termoestático **IMEX TURN CLEAN SYSTEM (patentado)**, con sensor Vernet.
- Rociador de acero inox. redondo Ø20 cm, extraplano, cromado y antical.
- Barra extensible de 94/130 cm
- Mango ducha redondo 3 posiciones.
- Grifería termostática de latón cromado con distribuidor incorporado.
- Presión máximo 8 at. mínimo 0,75 at.
- Caudal medio 12 l/min.
- Flexo reforzado 1,5 m.

Precio : **189 €**

IVA NO INCLUIDO



Grifería con certificación

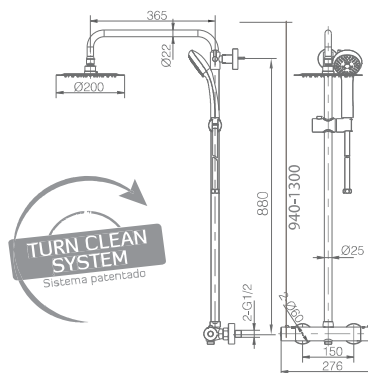



PROFESSIONAL
IMEX
DESIGN

CRETA

SERIE



Ref. : **BTC018**

Rociador de acero inox. redondo Ø20 cm, extraplano, cromado y antical.
 Barra extensible de 88/130 cm
 Mango ducha redondo 3 posiciones.
 Grifería termostática de latón cromado con distribuidor incorporado.
 Presión máximo 6 at. mínimo 1.5 at.
 Caudal medio 12 l/min.
 Flexo reforzado 1,5 m.
 Cartucho termoestático Vernet.

Precio : **185 €**

IVA NO INCLUIDO

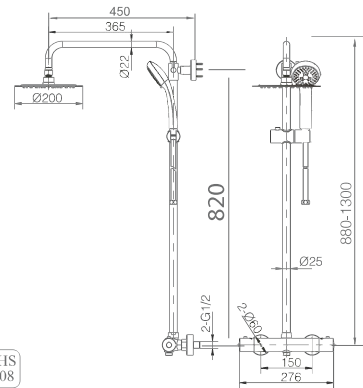

NF 77	EN 1111	ASSE 1016	ASSE 1070	ASSE 1017	NHS D08
----------	------------	--------------	--------------	--------------	------------



Cuerpo
frio

CRETA

SERIE

Ref. : **BTC018-5**

Mango ducha redondo 3 posiciones.
Grifería termostática ducha de latón cromado con distribuidor incorporado y cuerpo frío.
Soporte para mango de ducha ABS.
Presión máximo 6 at.,mínimo 1.5 at.
Caudal medio 12 l/min.
Flexo reforzado extensible 1,7/1,9 m.
Cartucho termostático Vernet.

Precio : **119 €**

IVA NO INCLUIDO

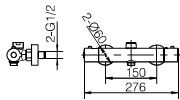





AMSTERDAM

SERIE

Ref. : **GTAM015**

Rociador de acero inox. redondo 25cm, extraplano, cromado y antical.
Barra extensible redonda de 88/124 cm
Mango ducha redondo 3 posiciones.
Grifería termostática de latón cromado con distribuidor incorporado.
Presión máximo 6 at. mínimo 1.5 at.
Caudal medio 12 l/min.
Flexo reforzado 1,5 m.
Cartucho termostático Sedal.

Precio : **214 €**

IVA NO INCLUIDO

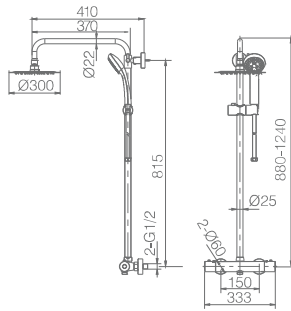



PRAGA

SERIE

Los detalles representan la perfección; sus líneas ovaladas le aportan gran belleza y distinción, siendo un modelo único y exclusivo.



Ref. : BTP012

Rociador de acero inox. ovalado 20x30 cm, extraplano, cromado y antical.
Barra extensible ovalada de 85/138 cm
Mango ducha redondo 3 posiciones.
Grifería termostática de latón cromado con distribuidor incorporado.
Presión máximo 6 at. mínimo 1.5 at.
Caudal medio 12 l/min.
Flexo PVC 1,5 m.
Cartucho termoestático Sedal.

Precio : 216 €

IVA NO INCLUIDO



8 476023 770231

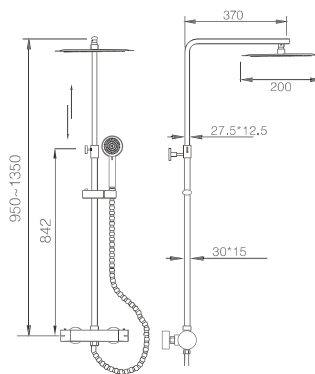



PROFESSIONAL
IMEX
DESIGN

LONDRES

SERIE

Uno de los modelos más competitivos de nuestra marca, ya que su relación calidad precio es excelente.

Ref. : **BTL011**

Rociador de acero inox. redondo Ø20 cm, extraplano, cromado y antical.
Barra extensible de 94/130 cm
Mango ducha redondo 3 posiciones.
Grifería termostática de latón cromado con distribuidor incorporado.
Presión máximo 6 at. mínimo 1.5 at.
Caudal medio 12 l/min.
Flexo reforzado 1,5 m.
Cartucho termostático Sedal.

Precio : **175 €**

IVA NO INCLUIDO



Grifería con certificación

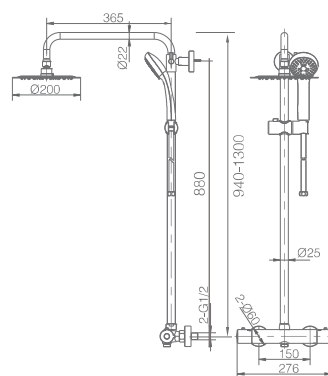





LONDRES

NEGRO MATE

SERIE

Ref. : BTL011/NG

Rociador de acero inox redondo Ø20 cm, extraplano, negro mate y antical.
 Barra extensible de 94/130 cm
 Mango ducha redondo 3 posiciones.
 Grifería termostática de latón negro con distribuidor incorporado.
 Presión máximo 6 at. mínimo 1,5 at.
 Caudal medio 12 l/min.
 Flexo reforzado PVC negro mate 1,5 m.
 Cartucho termostático Sedal.

Precio : 225 €

IVA NO INCLUIDO



Grifería con certificación

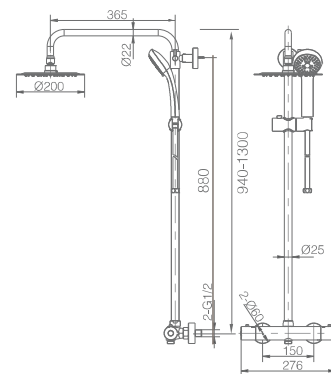

LONDRES

BLANCO MATE

SERIE



Ref. : BTL011/BL

Rociador de acero inox. redondo Ø20 cm, extraplano, blanco mate y antical.
 Barra extensible de 94/130 cm
 Mango ducha redondo 3 posiciones.
 Grifería termostática de latón blanco mate con distribuidor incorporado.
 Presión máximo 6 at, mínimo 1.5 at.
 Caudal medio 12 l/min.
 Flexo reforzado PVC 1,5 m.
 Cartucho termostático Sedal.

Precio : 225 €

IVA NO INCLUIDO



Grifería con certificación

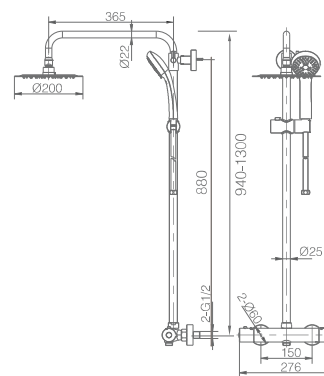





PROFESSIONAL
IMEX
DESIGN

BLED

SERIE Made in Europe

Uno de nuestros mejores productos. Durabilidad, resistencia y funcionamiento a muy baja presión hacen de este modelo uno de los más versátiles.

Ref. : **BTB010**

Rociador de acero inox. redondo Ø20 cm, extraplano, cromado y antical.
Barra extensible de 90/150 cm
Mango ducha redondo 3 posiciones.
Grifería termostática de latón cromado con distribuidor incorporado.
Presión máximo 6 at. mínimo 0,75 at.
Caudal medio 12 l/min.
Flexo reforzado 1,5 m.
Cartucho polímero Vernet.

Precio : **254 €**

IVA NO INCLUIDO



Grifería con certificación

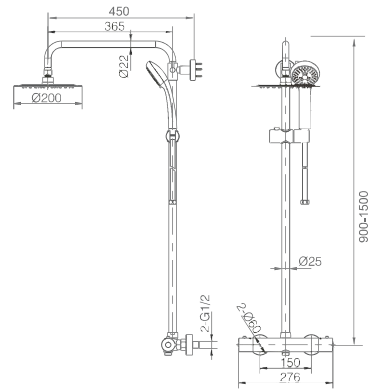



VIGO

SERIE



Ref. : **BTV013**

Rociador de acero inox. cuadrado 20x20 cm, extraplano, cromado y antical.
Barra de ducha extensible de 87/130 cm
Mango ducha cuadrado.
Grifería termostática de latón cromado con distribuidor incorporado.
Presión máximo 6 at. mínimo 1,5 at.
Caudal medio 12 l/min.
Flexo reforzado 1,5 m.
Cartucho polímero Vernet.

Precio : **270 €**

IVA NO INCLUIDO



Grifería con
certificación

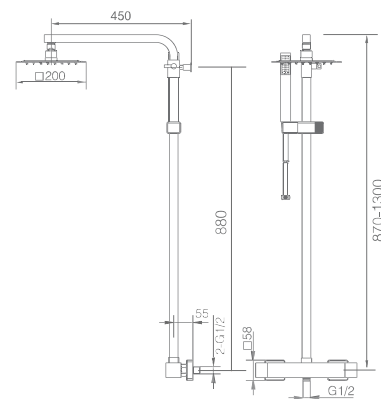

VIGO

NEGRO MATE

SERIE



Ref. : BTV013/NG

Rociador de acero inox. cuadrado 20x20 cm, extraplano, negro mate y antical.
Barra de ducha extensible de 87/130 cm
Mango ducha cuadrado.
Grifería termostática de latón negro mate con distribuidor incorporado.
Presión máximo 6 at. mínimo 1,5 at.
Caudal medio 12 l/min.
Flexo negro mate reforzado PVC 1,5 m.
Cartucho polímero Vernet.

Precio : 299 €

IVA NO INCLUIDO



Grifería con certificación

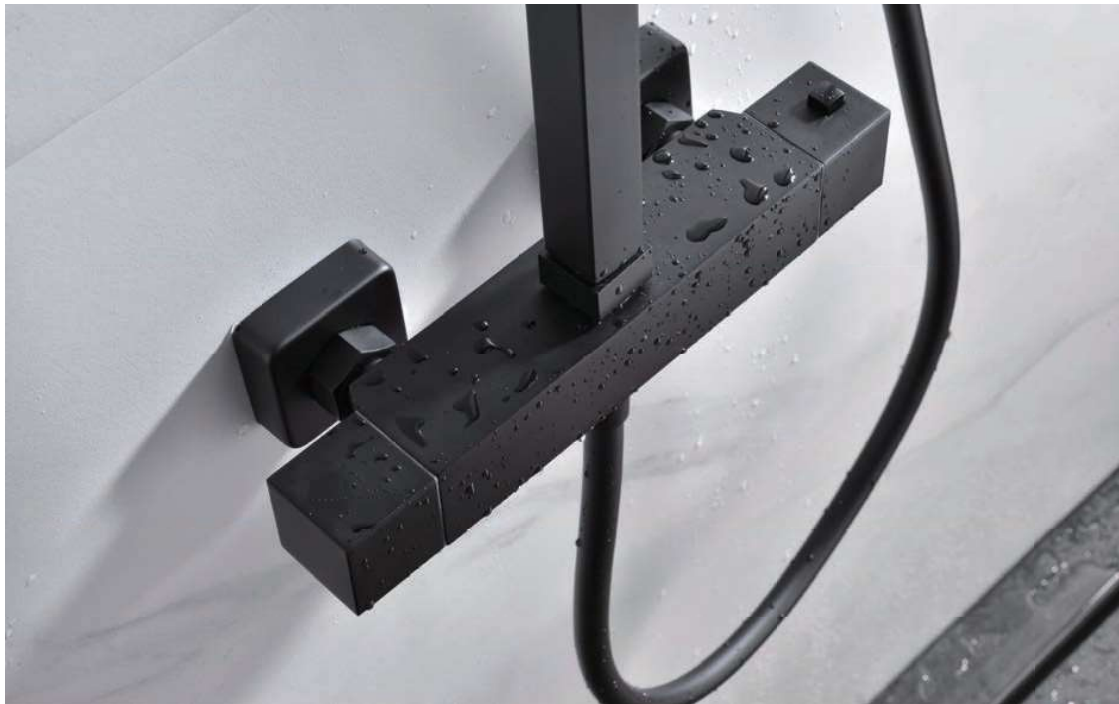
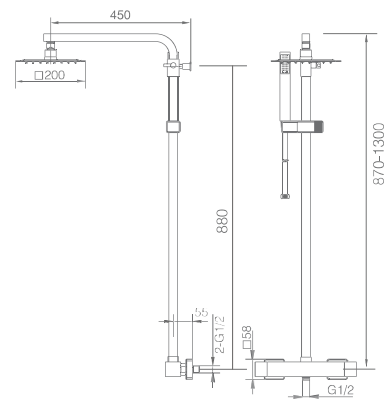





SIDNEY

SERIE

Ref. : **BTS016**

Rociador de acero inox. ovalado 20x30 cm, extraplano, cromado y antical.

Barra de bañera extensible de 101/163,5 cm

Mango ducha redondo.

Grifería termostática de latón cromado con distribuidor incorporado y cascada.

Presión máximo 6 at. mínimo 2 at.

Caudal medio 12 l/min.

Flexo PVC 1,5 m.

Cartucho polímero Vernet.

Precio : **295 €**
IVA NO INCLUIDO

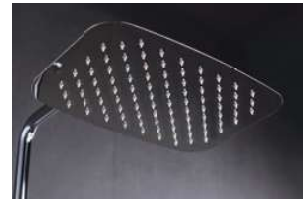
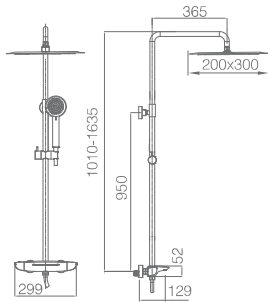

DUCHAS



EMPOTRADAS

La máxima expresión del diseño y las últimas novedades del mercado nos conducen a la integración de los productos en el baño.
IMEX se ha adaptado a los tiempos con la creación de diversas series empotradas.





ARUBA

SERIE

Líneas redondeadas y sutiles con un marcado carácter de diseño exclusivo y diferenciado.



Ref. : GPA015

Rociador de acero inox. redondo 25cm, extraplano, cromado y antical.
Tubo salida pared redondo.

Barra de latón cromado con entrada de agua directa a pared y mango ducha redondo 2 posiciones.

Grifería monomando empotrada de dos vías de latón cromado.

Presión máximo 6 at, mínimo 1.5 at.

Caudal medio 12 l/min.

Flexo de PVC de 1.5 m.

Cartucho cerámico 35mm.

Precio : 209 €

IVA NO INCLUIDO

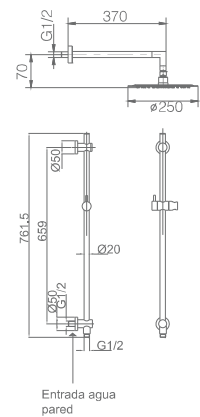



BAHAMAS

SERIE

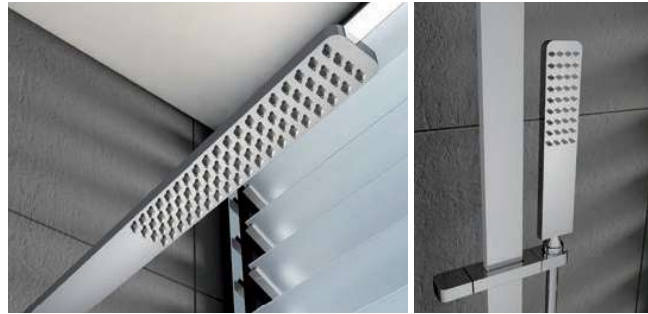

Ref. : **GPH016/CR**

Barra de latón cromado y rociador integrado con distribuidor incorporado, dos vías, entrada de agua a pared.
Grifería monomando empotrada de una vía de latón cromado.
Presión máximo 6 at.mínimo 1.5 at.
Caudal medio 12 l/min.
Flexo de PVC de 1,5 m y mango de ducha.
Cartucho cerámico 35mm.

Precio : **299 €**

IVA NO INCLUIDO

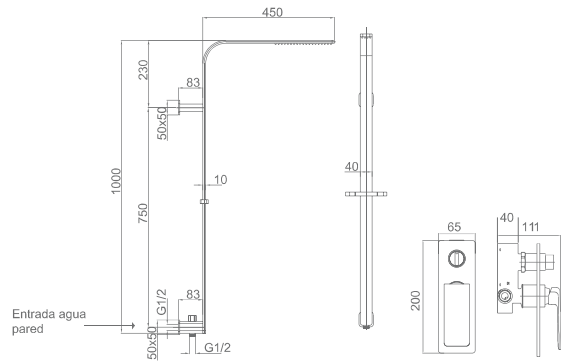

BAHAMAS BLANCO MATE

SERIE



Ref. : **GPH016/BL**

Barra de latón lacada blanco mate y rociador integrado con distribuidor incorporado, dos vías entrada de agua a pared.
Grifería monomando empotrada de una vía blanco mate.
Presión máximo 6 at.mínimo 1.5 at.
Caudal medio 12 l/min.
Flexo de PVC blanco mate de 1,5 m y mango de ducha blanco mate.
Cartucho cerámico 35mm.

Precio : **329 €**
IVA NO INCLUIDO

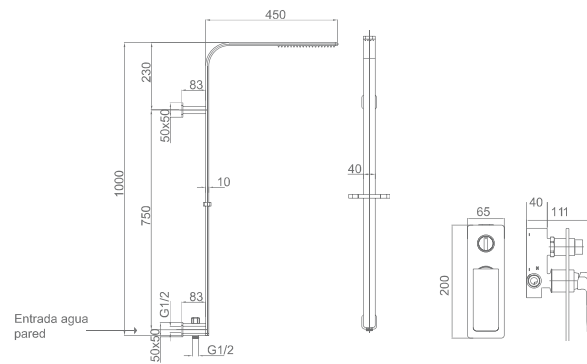





BAHAMAS NEGRO MATE

SERIE



Ref. : **GPH016/NG**

Barra de latón lacada negro mate y rociador integrado con distribuidor incorporado, dos vías entrada de agua a pared.
Grifería monomando empotrada de una vía negro mate.
Presión máximo 6 at.mínimo 1.5 at.
Caudal medio 12 l/min.
Flexo de PVC negro mate de 1,5 m y mango de ducha negro mate.
Cartucho cerámico 35mm.

Precio : **339 €**
IVA NO INCLUIDO

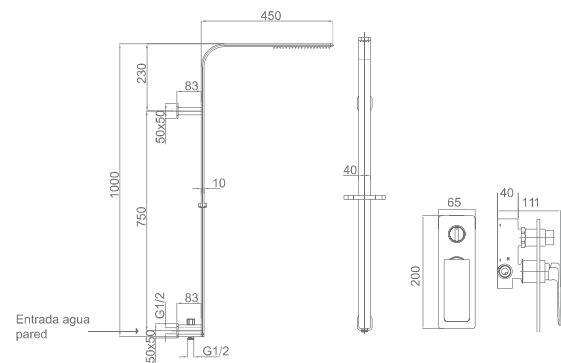

BORNEO

SERIE

Ref. : **GPB022**

Rociador cuadrado, acero inox. 25x25 cm, extraplano, cromado y antical.
Tubo salida pared cuadrado.
Barra de latón cromado con entrada de agua directa a pared y mango ducha cuadrado 3 posiciones.
Grifería monomando empotrada de dos vías de latón cromado.
Presión máximo 6 at, mínimo 1.5 at.
Caudal medio 12 l/min.
Flexo de PVC de 1,5 m.
Cartucho cerámico 35mm.

Precio : **215 €**

IVA NO INCLUIDO

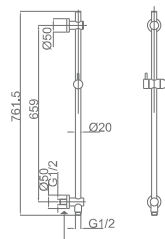
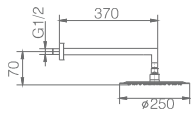

Entrada agua pared







OSLO

SERIE



Líneas redondeadas y sutiles con un marcado carácter de diseño exclusivo y diferenciado.

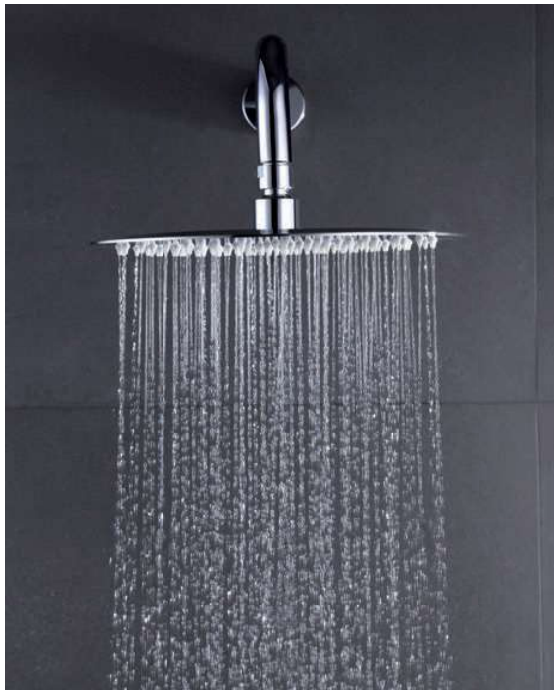

OSLO

SERIE

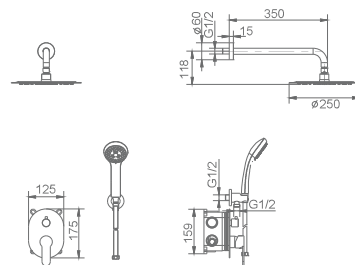

Ref. : GPE005

Rociador de acero inox. redondo Ø25cm, extraplano, cromado y antical.
Tubo salida pared.
Mango ducha redondo.
Grifería monomando de latón cromado con caja de registro dos vías.
Presión máximo 6 at. mínimo 1 at.
Caudal medio 12 l/min.
Distribuidor redondo de latón cromado.
Flexo PVC 1,5 m y mango de ducha.
Cartucho monomando cerámico 35mm.
Soporte salida pared



Precio : 189 €
IVA NO INCLUIDO



Grifería con
certificación



MÓNACO

SERIE

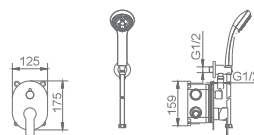
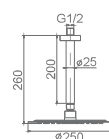

Ref. : GT003

Rociador de acero inox. redondo Ø25cm, extraplano, cromado y antical.
Tubo salida techo.
Mango ducha redondo.
Grifería monomando de latón cromado con caja de registro dos vías.
Presión máximo 6 at. mínimo 1 at.
Caudal medio 12 l/min.
Distribuidor redondo de latón cromado.
Flexo PVC 1,5 m y mango de ducha.
Cartucho monomando cerámico 35mm.
Soporte salida pared



Precio : 189 €
IVA NO INCLUIDO



Grifería con
certificación





DUBLÍN

SERIE



DUBLÍN

SERIE

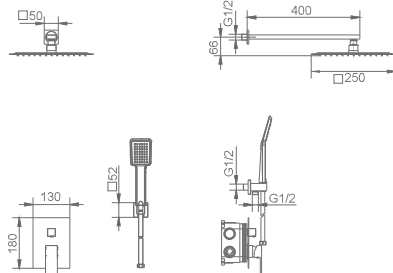

Ref. : GPE006

Rociador de acero inox. cuadrado 25x25cm, extraplano, cromado y antical.

Tubo salida pared.

Mango ducha cuadrado.

Grifería monomando de latón cromado con caja de registro dos vías.

Presión máximo 6 at. mínimo 1 at.

Caudal medio 12 l/min.

Distribuidor cuadrado de latón cromado.

Flexo PVC 1,5 m y mango de ducha.

Cartucho monomando cerámico 35mm.

Soporte salida pared

Precio : 215 €

IVA NO INCLUIDO



Grifería con
certificación



BERLÍN

SERIE

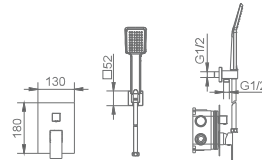
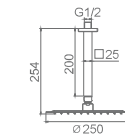

Ref. : GT006

Rociador de acero inox. cuadrado 25x25cm, extraplano, cromado y antical.
Tubo salida techo.
Mango ducha cuadrado.
Grifería monomando de latón cromado con caja de registro dos vías.
Presión máximo 6 at. mínimo 1 at.
Caudal medio 12 l/min.
Distribuidor cuadrado de latón cromado.
Flexo PVC 1,5 m y mango de ducha.
Cartucho monomando cerámico 35mm
Soporte salida pared



Precio : 215 €
IVA NO INCLUIDO





DUBLÍN NEGRO MATE

SERIE

Ref. : GPE006/NG

Rociador de acero inox. cuadrado 25x25cm, extraplano, negro mate y antical.
Tubo salida pared.
Mango ducha cuadrado.
Grifería monomando de latón negro con caja de registro dos vías.
Presión máximo 6 at. mínimo 1 at.
Caudal medio 12 l/min.
Distribuidor cuadrado de latón negro.
Flexo PVC negro mate 1,5 m.
Cartucho monomando cerámico 35mm.
Soporte salida pared negro.

Precio : 240 €

IVA NO INCLUIDO



Grifería con
certificación

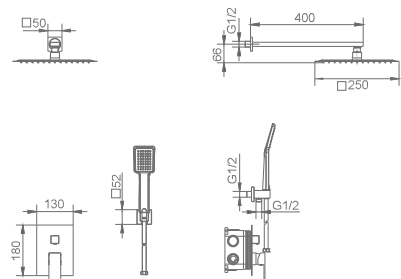
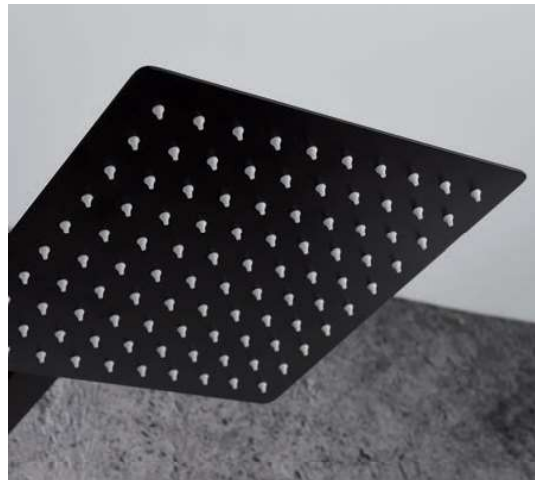



DUBLÍN
BLANCO MATE
SERIE



Ref. : GPE006/BL

Rociador de acero inox. cuadrado 25x25cm, extraplano,
blanco mate y antical.
Tubo salida pared.
Mango ducha cuadrado.
Grifería monomando de latón blanco con caja de registro dos vías.
Presión máximo 6 at. mínimo 1 at.
Caudal medio 12 l/min.
Distribuidor cuadrado de latón blanco.
Flexo PVC blanco mate 1,5 m.
Cartucho monomando cerámico 35mm.
Soporte salida pared blanco.

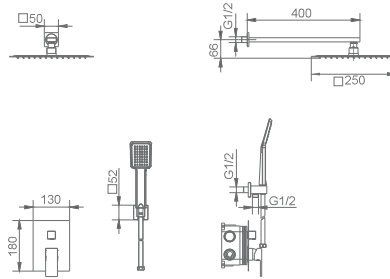

Precio : 240 €
IVA NO INCLUIDO



Grifería con
certificación







VOLGA

SERIE

Ref. : **GET015** (Encastrado a techo)

Rociador de acero inox. Cuadrado 40X40cm,extraplano,cromado y antical.
Mango ducha cuadrado.
Grifería monomando de latón cromado dos vías con caja de registro.
Presión máximo 6 at,minimo 1 at.
Caudal medio 12 l/min.
Distribuidor cuadrado de latón cromado.
Flexo PVC 1,5 m.
Cartucho monomando cerámico 35mm.
Incluye premarco.
Soporte mango ducha salida pared

Precio : **299 €**
IVA NO INCLUIDO



8 410201 160625

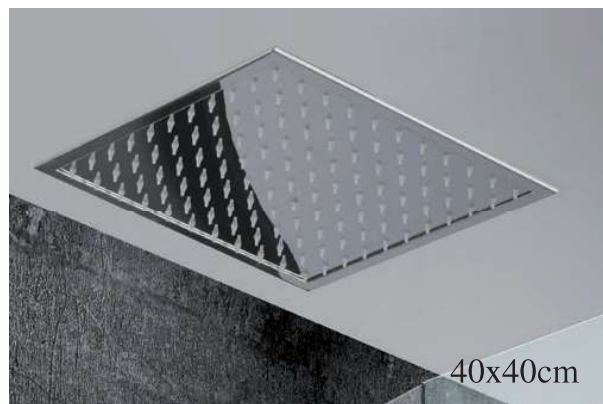

40x40cm

GALES

SERIE

Ref. : **GTG008** (Encastrado a techo)

Rociador de acero inox. Cuadrado 30X30cm,extraplano,cromado y antical.
Mango ducha cuadrado.
Grifería monomando de latón cromado dos vías con caja de registro.
Presión máximo 6 at,minimo 1 at.
Caudal medio 12 l/min.
Distribuidor cuadrado de latón cromado.
Flexo PVC 1,5 m.
Cartucho monomando cerámico 35mm.
Incluye premarco.
Soporte mango ducha salida pared

Precio : **259 €**
IVA NO INCLUIDO



8 476023 772952

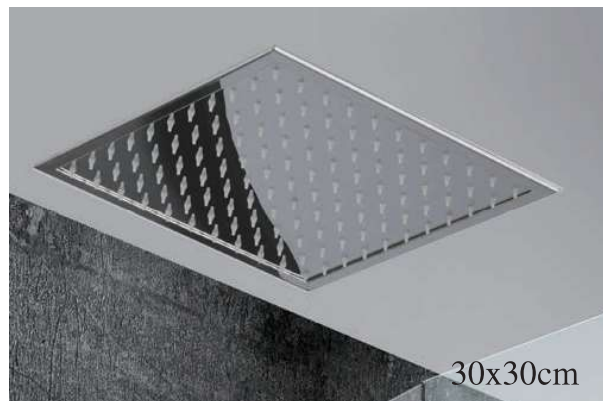

30x30cm

SUMATRA

SERIE

Conjunto de ducha de nueva creación. Gracias a su espectacular rociador de grandes dimensiones y diversas funciones capaces de aportar relax y confort excepcionales.



Rociador de acero inox. rectangular 48X59cm, extraplano, cromado y antical con tres salidas de agua opcionales.
 Mango ducha cuadrado.
 Grifería monomando de latón cromado 4 vías con caja de registro.
 Presión máximo 6 at. mínimo 3 at.
 Caudal medio 12 l/min.
 Distribuidor cuadrado de latón cromado.
 Flexo PVC 1,5 m.
 Cartucho monomando cerámico 35mm.
 Soporte mango ducha salida a pared.
 Incluye accesorios de montaje para instalación a techo.

Ref. : **GTS019**
 SIN PREMARCO

Precio : **530 €**
 IVA NO INCLUIDO



8 410201 131625

Ref. : **GTS019/P**
 CON PREMARCO (recomendado)

Precio : **634 €**
 IVA NO INCLUIDO



8 410201 541622

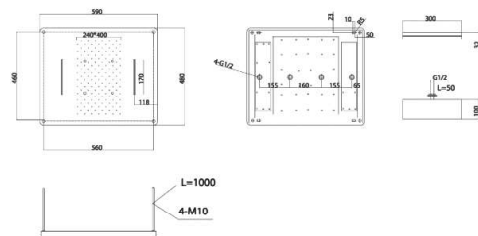







RODAS

SERIE

Conjunto de ducha de nueva creación. Gracias a su espectacular rociador de grandes dimensiones y diversas funciones capaces de aportar relax y confort excepcionales.

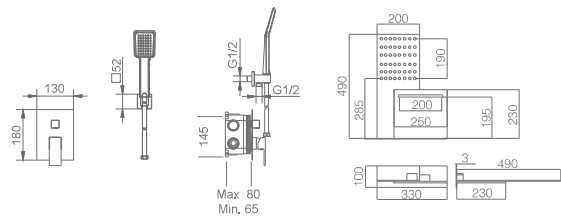
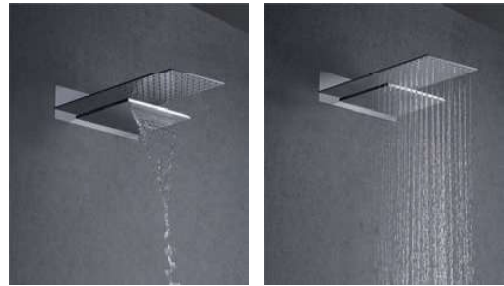

Video spot



Video técnico profesional



Ref. : **GTR049**

Rociador de acero inox. rectangular 48x33,5 cm, extraplano, cromado y anticál con dos salidas de agua opcionales. Efecto lluvia y cascada.

Mango ducha cuadrado.

Grifería termostática de latón cromado 3 vías con caja de registro.

Presión máximo 6 at. mínimo 3 at.

Caudal medio 12 l/min.

Distribuidor cuadrado de latón cromado.

Flexo PVC 1,5 m y mango de ducha.

Cartucho termostático TURN CLEAN SYSTEM autolimpiable.

Soporte mango ducha salida a pared.

Precio : **629 €**

IVA NO INCLUIDO



RODAS

NEGRO MATE

SERIE

Conjunto de ducha de nueva creación. Gracias a su espectacular rociador de grandes dimensiones y diversas funciones capaces de aportar relax y confort excepcionales.

Ref. : **GTR049/NG**

Rociador de acero inox. rectangular 48x33,5 cm, extraplano, negro mate y antical con dos salidas de agua opcionales. Efecto lluvia y cascada. Mango ducha cuadrado. Grifería termostática de latón negro mate 3 vías con caja de registro. Presión máximo 6 at. mínimo 3 at. Caudal medio 12 l/min. Distribuidor cuadrado de latón negro mate. Flexo PVC negro mate 1,5 m. **Cartucho termostático TURN CLEAN SYSTEM autolimpiable.** Soporte mango ducha salida a pared.

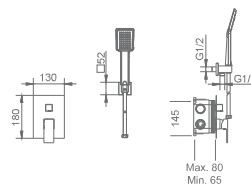
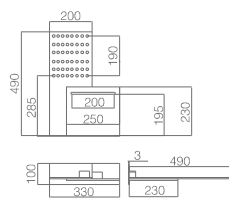

Precio : **669 €**
IVA NO INCLUIDO



Vídeo spot



Vídeo técnico profesional







MÁLAGA

SERIE

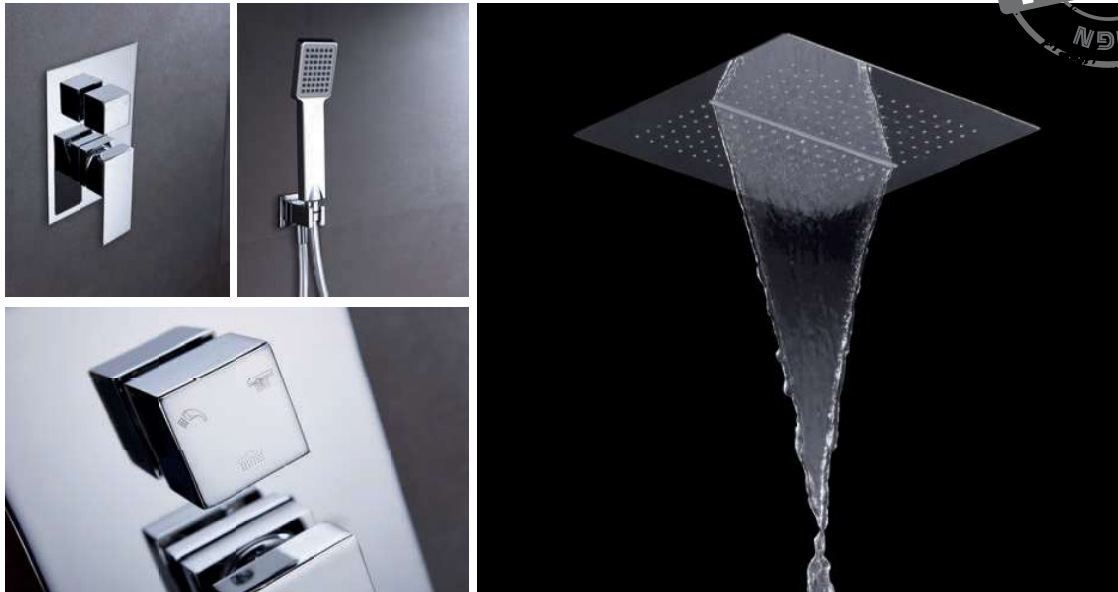

Ref. : **GTS020** Incluye premarco a techo

Rociador de acero inox. cuadrado 40X40cm, extraplano, cromado y antical con dos salidas de agua opcionales.

Mango ducha cuadrado.

Grifería monomando de latón cromado 3 vías con caja de registro.

Presión máximo 6 at. mínimo 3 at.

Caudal medio 12 l/min.

Distribuidor cuadrado de latón cromado.

Flexo PVC 1,5 m.

Cartucho monomando cerámico 35mm.

Soporte mango ducha salida a pared.

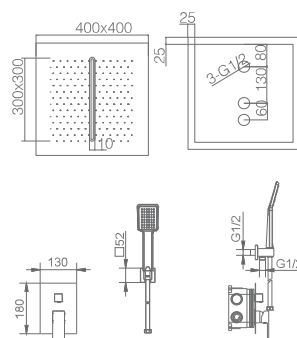

Precio : **385 €**

IVA NO INCLUIDO



8 410201 292623



FORMENTERA

SERIE

Detalles que representan la perfección, modelo diseñado para aportar un máximo confort y elegancia, creando un espacio en el baño único e irrepetible.





Ref. :GPE008

Rociador cascada 30 cm, cromado, acero S304.
Mango ducha Cuadrado.
Grifería monomando de latón cromado de 3 vías.
Presión máximo 6 at, mínimo 4 at.
Caudal medio 12 l/min.
Distribuidor Cuadrado de latón cromado.
Flexo PVC 1,5 m.
Cartucho monomando cerámico de 35mm.
Tres Jet Latón cromado y antical.
Soporte mango ducha salida a pared.

Precio : 468 €

IVA NO INCLUIDO



JAVA

SERIE

Conjunto de baño empotrado, máxima expresión del relax en su estado pleno, gracias a su cascada de grandes dimensiones. Es un producto polivalente con tres funciones de uso: llenado de bañera, rociador superior y mango de ducha.

Ref. :GPV017

Rociador Cuadrado 25x25 cm cromado y antical.
Mango ducha Cuadrado 3 posiciones.
Grifería monomando de latón cromado 3 vías.
Caño de bañera cascada de 30 cm, acero S304.
Presión máximo 6 at. mínimo 3 at.
Caudal medio 12 l/min.
Distribuidor Cuadrado de latón cromado.
Flexo PVC 1,5 m.
Cartucho monomando cerámico 35mm.
Soporte mango ducha salida a pared.
Tubo pared cuadrado

Precio : 290 €
IVA NO INCLUIDO

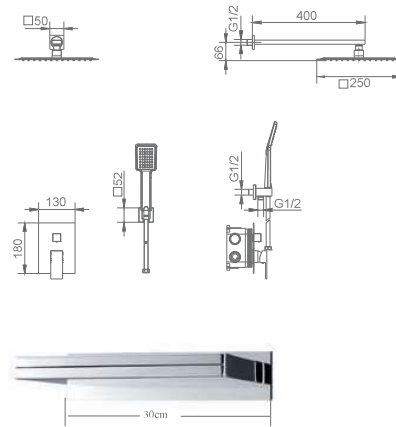





ITALIA

SERIE



ITALIA

SERIE

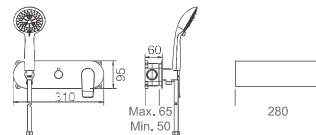
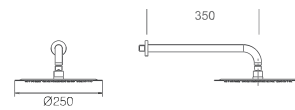

Ref. : GPI013

Rociador de acero inox. redondo Ø25cm, extraplano, cromado y antical.

Tubo salida pared de latón.

Mango ducha redondo.

Grifería monomando de latón cromado 2 vías con caja de registro.

Presión máximo 6 at. mínimo 1 at.

Caudal medio 12 l/min.

Distribuidor redondo de latón cromado.

Flexo PVC 1,5 m.

Cartucho monomando cerámico 35mm.



Precio : 199 €

IVA NO INCLUIDO



Grifería con certificación



FRANCIA

SERIE

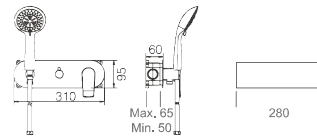

Ref. : GTF014

Rociador de acero inox. redondo Ø25cm, extraplano, cromado y antical.
Tubo salida techo de latón.
Mango ducha redondo.
Grifería monomando de latón cromado 2 vías con caja de registro.
Presión máximo 6 at. mínimo 1 at.
Caudal medio 12 l/min.
Distribuidor redondo de latón cromado.
Flexo PVC 1,5 m .
Cartucho monomando cerámico 35mm.



Precio : 199 €

IVA NO INCLUIDO



Grifería con certificación





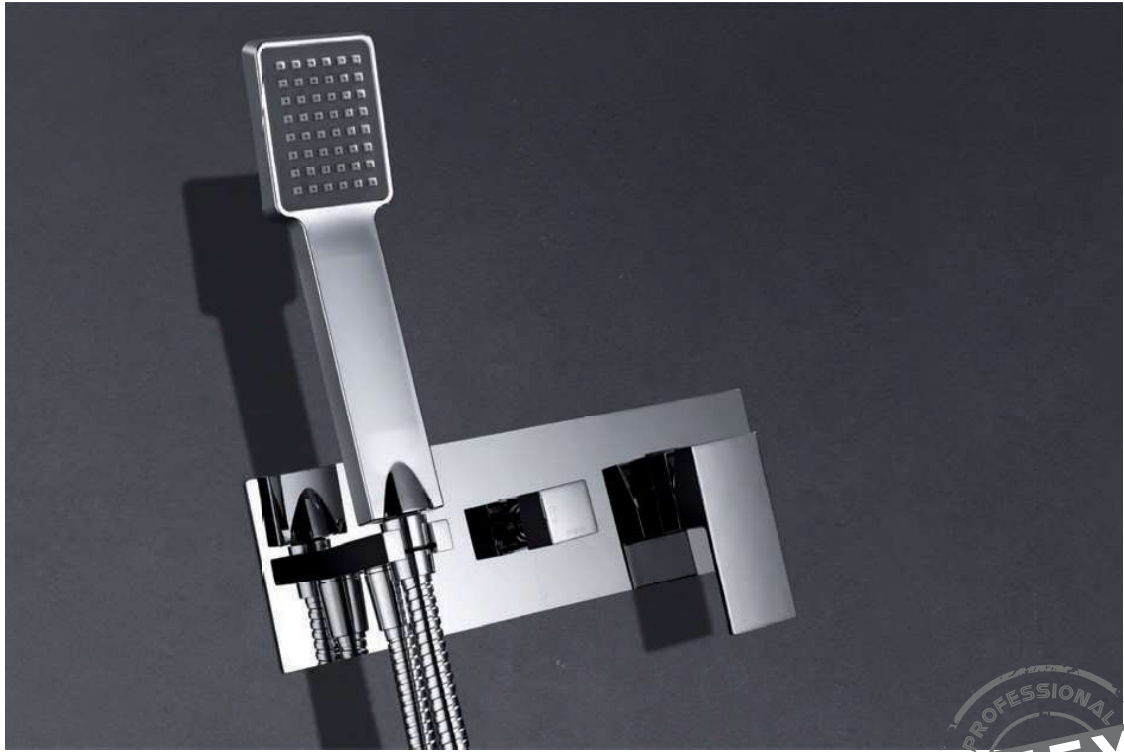

Empotrada lineal que se integra a la perfección en cualquier ambiente.



NORUEGA

SERIE

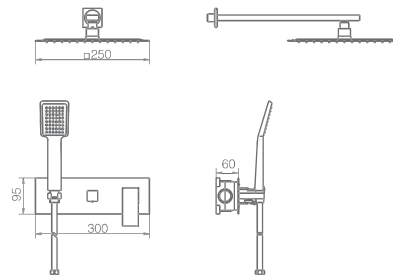

Ref. : GPN011

Rociador de acero inox. Cuadrado
25X25cm,extraplano,cromado y antical.
Tubo salida pared de latón.
Mango ducha cuadrado.
Grifería monomando de latón cromado 2 vías, caja de registro.
Presión máximo 6 at.mínimo 1 at.
Caudal medio 12 l/min.
Distribuidor cuadrado de latón cromado.
Flexo PVC 1,5 m.
Cartucho monomando cerámico 35mm.



Precio : 230 €
IVA NO INCLUIDO



FINLANDIA

SERIE

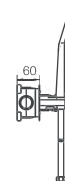
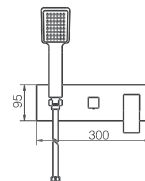
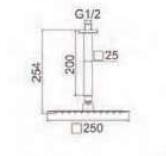

Ref. : GTF012

Rociador de acero inox. Cuadrado 25X25cm,extraplano,cromado y antical.
Tubo salida techo de latón.
Mango ducha cuadrado.
Grifería monomando de latón cromado 2 vías, caja de registro.
Presión máximo 6 at.mínimo 1 at.
Caudal medio 12 l/min.
Distribuidor cuadrado de latón cromado.
Flexo PVC 1,5 m.
Cartucho monomando cerámico 35mm.

Precio: 230 €
IVA NO INCLUIDO







Termostática empotrada de líneas cuadradas de alta precisión, la excelencia en estado puro, se la otorgan unas líneas minimalistas.

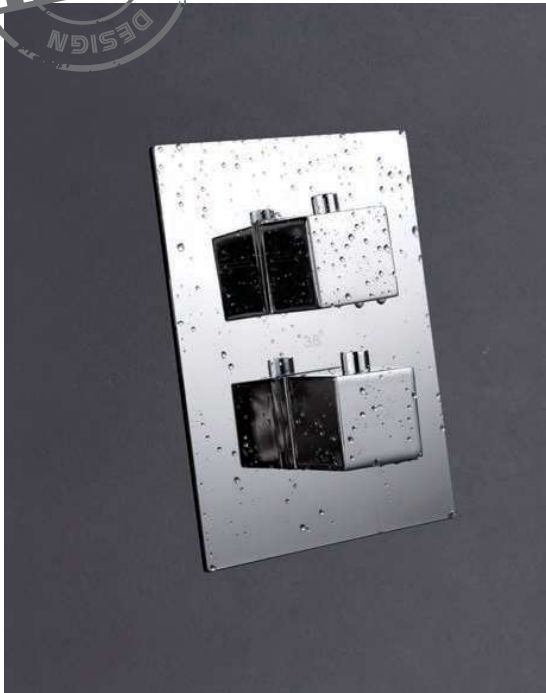

ONS

SERIE

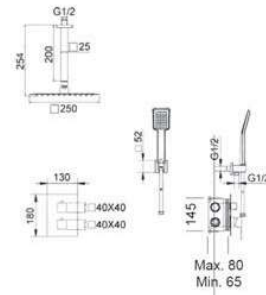

Ref. : GPC010

Rociador de acero inox. Cuadrado 25X25cm, extraplano, cromado y antical.
Tubo salida techo latón.
Mango ducha cuadrado.
Grifería termostática de latón cromado, 2 vías con caja de registro.
Presión máximo 6 at.mínimo 1 at.
Caudal medio 12 l/min.
Distribuidor cuadrado de latón cromado.
Flexo reforzado PVC 1,5 m
Cartucho termostático VERNET.
Soporte mango ducha con salida agua pared.

Precio : 299 €
IVA NO INCLUIDO



Grifería con
certificación
ACS



CIES

SERIE

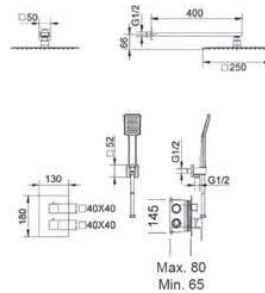

Ref. : GPC009

Rociador de acero inox. Cuadrado 25X25cm, extraplano, cromado y antical.
 Tubo salida pared de latón.
 Mango ducha cuadrado.
 Grifería termostática de latón cromado, 2 vías con caja de registro.
 Presión máximo 6 at.mínimo 1 at.
 Caudal medio 12 l/min.
 Distribuidor cuadrado de latón cromado.
 Flexo reforzado PVC 1,5 m
 Cartucho termostático VERNET
 Soporte mango ducha con salida agua pared.

Precio : 299 €
 IVA NO INCLUIDO



Grifería con certificación





Ref. : GPC009/NG

Rociador de acero inox Cuadrado 25X25cm, extraplano, negro mate y antical.
 Tubo salida pared de latón.
 Mango ducha cuadrado.
 Grifería termostática de latón negro, 2 vías con caja de registro.
 Presión máximo 6 at. mínimo 1 at.
 Caudal medio 12 l/min.
 Distribuidor cuadrado de latón negro.
 Flexo reforzado PVC negro mate 1,5 m
 Cartucho termostático VERNET
 Soporte mango ducha con salida agua pared negro.

Precio : 339 €
 IVA NO INCLUIDO

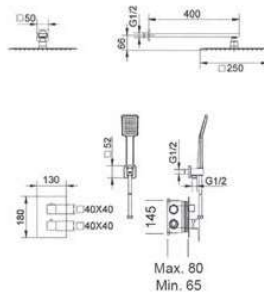

CIES
NEGRO MATE

SERIE



Ref. : GPC009/BL

Rociador de acero inox. Cuadrado 25X25cm, extraplano, blanco mate y antical.
 Tubo salida pared de latón.
 Mango ducha cuadrado.
 Grifería termostática de latón blanco, 2 vías con caja de registro.
 Presión máximo 6 at. mínimo 1 at.
 Caudal medio 12 l/min.
 Distribuidor cuadrado de latón blanco.
 Flexo reforzado PVC blanco mate 1,5 m
 Cartucho termostático VERNET
 Soporte mango ducha con salida agua pared blanco.

Precio : 339 €
 IVA NO INCLUIDO

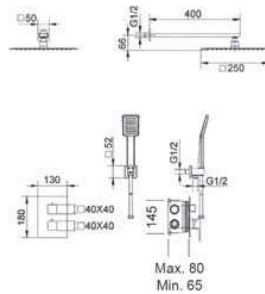

CIES BLANCO MATE

SERIE

MILOS SERIES

SERIE

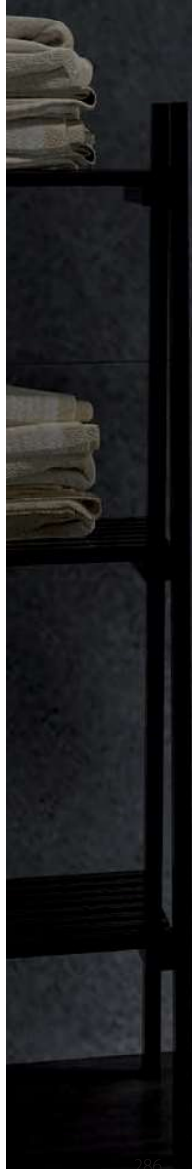



THALOS SERIES

SERIE

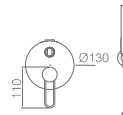
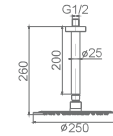

Ref. : GPT030

Rociador de acero inox. redondo 25Øcm, extraplano, cromado y antical.

Tubo salida techo latón cromado.

Mango ducha redondo.

Grifería monomando de latón cromado, 2 vías.

Presión máximo 6 at.mínimo 1 at.

Caudal medio 12 l/min.

Distribuidor redondo de latón cromado.

Flexo reforzado PVC 1,5 m

Cartucho monomando 35mm.

Soporte mango ducha con salida agua pared.

Precio : 186 €
IVA NO INCLUIDO



MILOS SERIES

SERIE

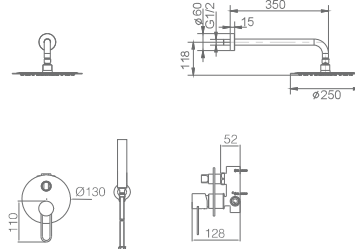

Ref. : GPM029

Rociador de acero inox. redondo 250cm, extraplano, cromado y antical.
Tubo salida pared latón cromado.
Mango ducha redondo.
Grifería monomando de latón cromado, 2 vías.
Presión máximo 6 at.mínimo 1 at.
Caudal medio 12 l/min.
Distribuidor redondo de latón cromado.
Flexo reforzado PVC 1,5 m
Cartucho monomando 35mm.
Soporte mango ducha con salida agua pared.

Precio : 186 €
IVA NO INCLUIDO





Ref. : GPM029/NG

Rociador de acero inox. redondo 250cm, extraplano, negro mate y antical.
 Tubo salida pared latón negro mate.
 Mango ducha redondo.
 Grifería monomando de latón negro mate, 2 vías.
 Presión máximo 6 at.mínimo 1 at.
 Caudal medio 12 l/min.
 Distribuidor redondo de latón negro mate.
 Flexo reforzado PVC 1,5 m
 Cartucho monomando 35mm.
 Soporte mango ducha con salida agua pared.

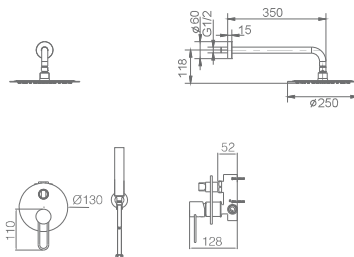

Precio : 209 €
 IVA NO INCLUIDO





Ref. : GPM029/BL

Rociador de acero inox. redondo 250cm, extraplano, blanco mate y antical.
 Tubo salida pared latón blanco mate.
 Mango ducha redondo.
 Grifería monomando de latón blanco mate, 2 vías.
 Presión máximo 6 at. mínimo 1 at.
 Caudal medio 12 l/min.
 Distribuidor redondo de latón blanco mate.
 Flexo reforzado PVC 1,5 m
 Cartucho monomando 35mm.
 Soporte mango ducha con salida agua pared.

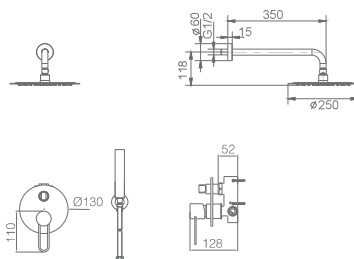

Precio : 209 €
 IVA NO INCLUIDO



MILOS SERIES

NEGRO ORO ROSA

SERIE





THALOS SERIES

SERIE

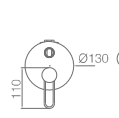
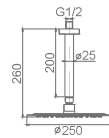

Ref. : GPT030/NOR

Rociador de acero inox. redondo 25Øcm, extraplano, oro rosa y antical.
Tubo salida techo latón negro mate, oro rosa.
Mango ducha redondo.
Grifería monomando de latón negro, oro rosa, 2 vías.
Presión máximo 6 at.mínimo 1 at.
Caudal medio 12 l/min.
Distribuidor redondo de latón negro, oro rosa.
Flexo reforzado PVC 1,5 m
Cartucho monomando 35mm.
Soporte mango ducha con salida agua pared.

Precio : 239 €
IVA NO INCLUIDO



MILOS SERIES

SERIE

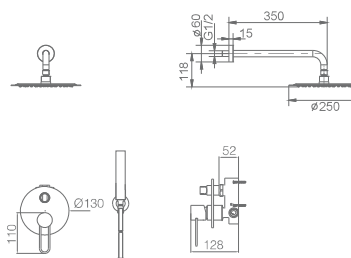

Ref. : GPM029/NOR

Rociador de acero inox. redondo 250cm, extraplano, oro rosa y antical.

Tubo salida pared latón negro mate, oro rosa.

Mango ducha redondo.

Grifería monomando de latón negro, oro rosa, 2 vías.

Presión máximo 6 at.mínimo 1 at.

Caudal medio 12 l/min.

Distribuidor redondo de latón negro, oro rosa.

Flexo reforzado PVC 1,5 m

Cartucho monomando 35mm.

Soporte mango ducha con salida agua pared.

Precio : 239 €

IVA NO INCLUIDO





ACERO
S 316
INOX

MOSCU

SERIE





ACERO
S 316
INOX

MOSCU

SERIE



Válido tanto para interior como exterior. Alta resistencia

MOSCU

SERIE



Ref. : GPK034

Rociador de acero inox. Aisi 316, máxima calidad anticorrosión y alta resistencia. Ø 25
 Tubo de acero inox. Aisi 316, máxima calidad anticorrosión y alta resistencia salida pared.
 Mango ducha redondo Aisi 316, máxima calidad anticorrosión y alta resistencia.
 Grifería monomando, Aisi 316, máxima calidad anticorrosión y alta resistencia, 2 vías con caja de registro.
 Presión máximo 6 at.mínimo 1 at.
 Caudal medio 12 l/min.
 Distribuidor cuadrado de acero Aisi 316.
 Flexo reforzado PVC 1,5 m
 Cartucho monomando 35mm.
 Soporte mango ducha con salida agua pared Aisi 316, máxima calidad anticorrosión y alta resistencia

Precio: 205 €
 IVA NO INCLUIDO

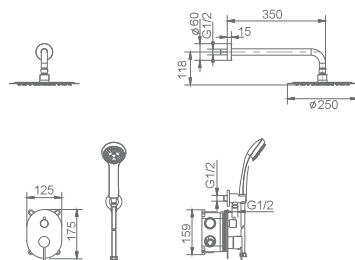



MADEIRA

SERIE

MADEIRA

SERIE



Video spot



Video técnico profesional



Ref. : GTM021

Rociador de acero inox. Cuadrado 25X25cm, extraplano, cromado y antical.
Tubo salida pared latón cromado.
Mango ducha cuadrado.
Grifería termostática de latón cromado, 2 vías con pulsador y caja de registro.
Presión máximo 6 at.mínimo 1 at.
Caudal medio 12 l/min.
Distribuidor de pulsador de latón cromado.
Flexo reforzado PVC 1,5 m
Cartucho termostático autolimpiable TURN CLEAN SYSTEM.
Soporte mango ducha con salida agua pared.

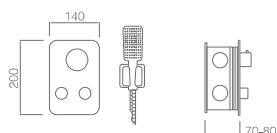
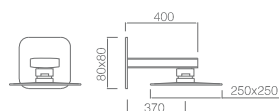

Precio : 299 €
IVA NO INCLUIDO



8 410201 393627

PORTUGAL

SERIE

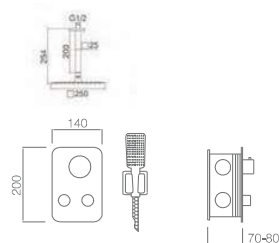

Ref. : GTP022

Rociador de acero inox. Cuadrado 25X25cm, extraplano, cromado y antical.

Tubo salida techo latón cromado.

Mango ducha cuadrado.

Grifería termostática de latón cromado, 2 vías con pulsador y caja de registro.

Presión máximo 6 at.mínimo 1 at.

Caudal medio 12 l/min.

Distribuidor de pulsador de latón cromado.

Flexo reforzado PVC 1,5 m

Cartucho termostático autolimpiable TURN CLEAN SYSTEM.

Soporte mango ducha con salida agua pared.



Video spot



Video técnico profesional



Precio : 299€
IVA NO INCLUIDO







MADEIRA NEGRO MATE

SERIE

MADEIRA

NEGRO MATE

SERIE



Video spot



Video técnico profesional



Ref. : GTM021/NG

Rociador de acero inox. Cuadrado 25X25cm, extraplano, negro mate y antical.
Tubo salida pared latón negro mate.
Mango ducha cuadrado.
Grifería termostática de latón negro mate, 2 vías con pulsador y caja de registro.
Presión máximo 6 at.mínimo 1 at.
Caudal medio 12 l/min.
Distribuidor de pulsador de latón negro mate.
Flexo reforzado PVC 1,5 m
Cartucho termostático autolimpiable TURN CLEAN SYSTEM.

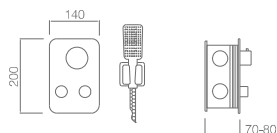
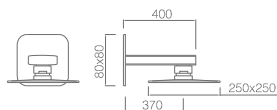

Precio : 329 €
IVA NO INCLUIDO



PORTUGAL

NEGRO MATE

SERIE



Video spot



Video técnico profesional



Ref. : GTP022/NG

Rociador de acero inox. Cuadrado 25X25cm, extraplano, negro mate y antical.

Tubo salida techo latón negro mate.

Mango ducha cuadrado.

Grifería termostática de latón negro mate, 2 vías con pulsador y caja de registro.

Presión máximo 6 at.mínimo 1 at.

Caudal medio 12 l/min.

Distribuidor de pulsador de latón negro mate.

Flexo reforzado PVC 1,5 m

Cartucho termostático autolimpiable TURN CLEAN SYSTEM.

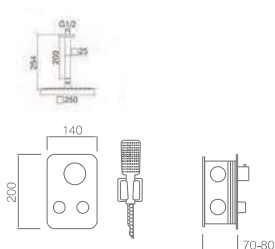

Precio : 329 €

IVA NO INCLUIDO





HIDRA

SERIE



HIDRA

SERIE



Video spot



Video técnico profesional



Ref. : GPH035

Rociador de acero inox. ovalado 20x30cm, extraplano, cromado y antical.
Tubo salida pared de latón.
Mango ducha ovalado.
Grifería termostática de latón cromado, 2 vías con pulsadores y caja de registro.
Presión máximo 6 at.mínimo 1 at.
Caudal medio 12 l/min.
Distribuidores con pulsador de latón cromado.
Flexo reforzado PVC 1,5 m
Cartucho termostático autolimpiante TURN CLEAN SYSTEM.
Soporte mango ducha con salida agua pared.



Precio : 299 €
IVA NO INCLUIDO



FEROE

SERIE



Vídeo spot



Vídeo técnico profesional



Ref. : GPF036

Rociador de acero inox. ovalado 20x30cm, extraplano, cromado y antical.

Tubo salida techo de latón.

Mango ducha ovalado.

Grifería termostática de latón cromado, 2 vías con pulsadores y caja de registro.

Presión máximo 6 at.mínimo 1 at.

Caudal medio 12 l/min.

Distribuidores con pulsador de latón cromado.

Flexo reforzado PVC 1,5 m

Cartucho termostático autolimpiable TURN CLEAN SYSTEM.

Soporte mango ducha con salida agua pared.

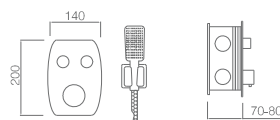
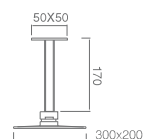

Precio : 299 €

IVA NO INCLUIDO





HIDRA NEGRO MATE

SERIE

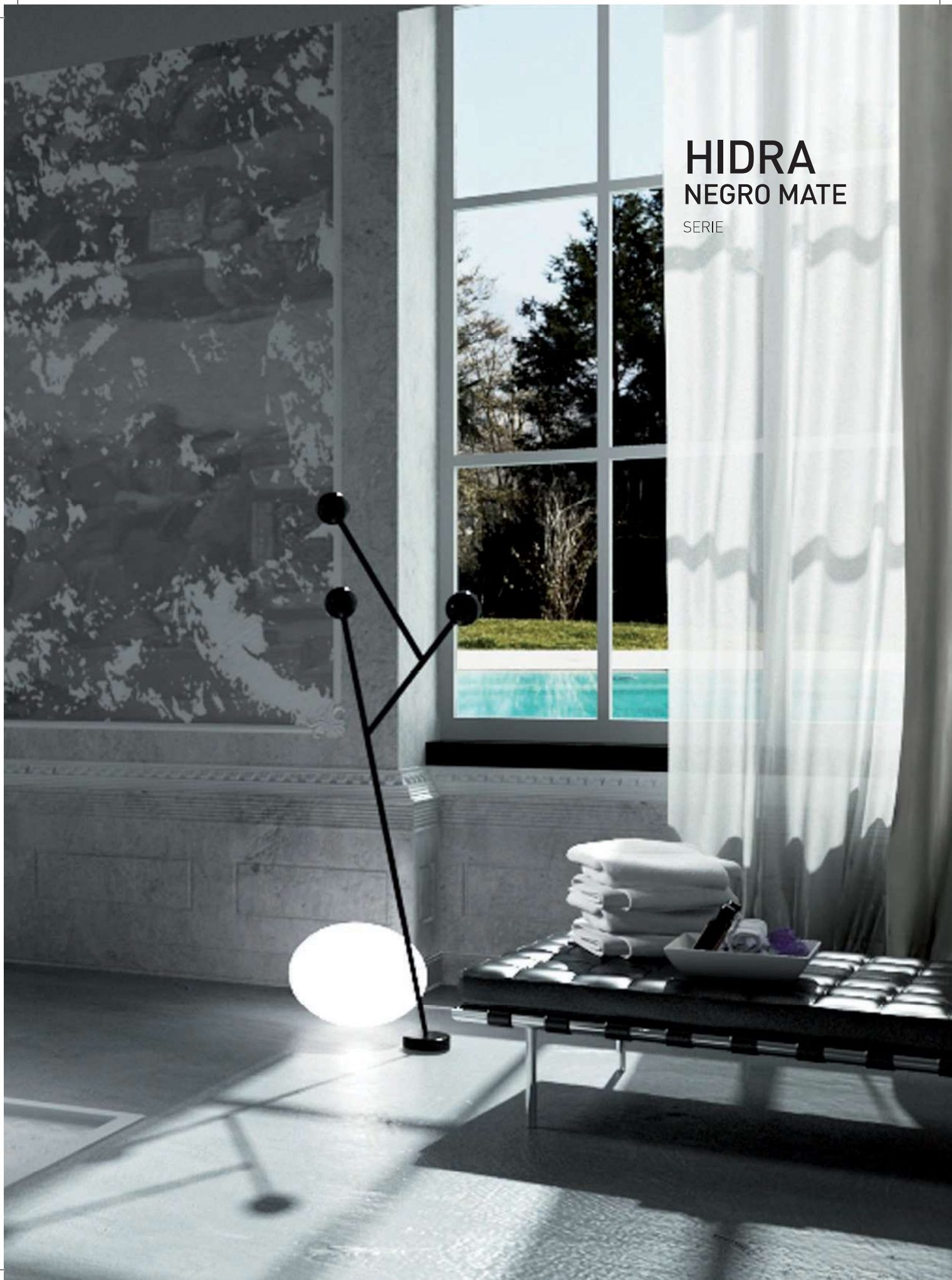

HIDRA

NEGRO MATE

SERIE



Ref. : GPH035/NG

Rociador de acero inox. ovalado 20x30cm, extraplano, negro mate y antical.
 Tubo salida pared de latón.
 Mango ducha ovalado.
 Grifería termostática de latón negro mate, 2 vías con pulsadores y caja de registro.
 Presión máximo 6 at.mínimo 1 at.
 Caudal medio 12 l/min.
 Distribuidores con pulsador de latón negro mate.
 Flexo reforzado PVC 1,5 m
Cartucho termostático autolimpiable TURN CLEAN SYSTEM.
 Soporte mango ducha con salida agua pared.

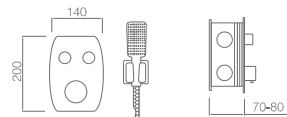
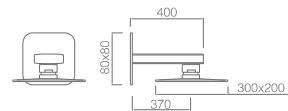

Precio : 329 €
 IVA NO INCLUIDO



Video spot



Video técnico profesional



FEROE

NEGRO MATE

SERIE



Video spot



Video técnico profesional



Ref. : GPF036/NG

Rociador de acero inox. ovalado 20x30cm, extraplano, negro mate y antical.

Tubo salida techo de latón.

Mango ducha ovalado.

Grifería termostática de latón negro mate, 2 vías con pulsadores y caja de registro.

Presión máximo 6 at.mínimo 1 at.

Caudal medio 12 l/min.

Distribuidores con pulsador de latón negro mate.

Flexo reforzado PVC 1,5 m

Cartucho termostático autolimpiable TURN CLEAN SYSTEM.

Soporte mango ducha con salida agua pared.

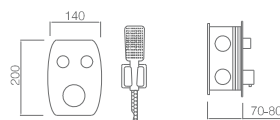
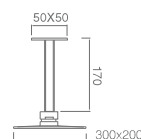

Precio : 329 €

IVA NO INCLUIDO



OLIMPO

SERIE

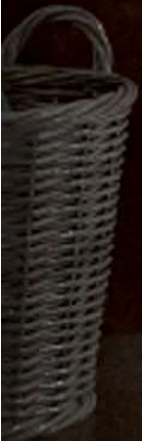



OLIMPO

SERIE

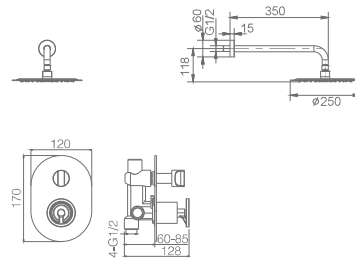

Ref. : GPC033

Rociador de acero inox. redondo Ø25cm, extraplano, cromado y antical.
Tubo salida pared de latón.
Mango ducha redondo.
Grifería monomando de latón cromado, 2 vías.
Presión máximo 6 at.mínimo 1 at.
Caudal medio 12 l/min.
Distribuidor de latón cromado.
Flexo reforzado PVC 1,5 m
Cartucho monomando 35mm.
Soporte mango ducha con salida agua pared.

Precio : 215 €
IVA NO INCLUIDO



VESUBIO

SERIE

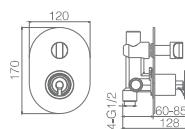
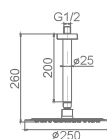

Ref. : GTV038

Rociador de acero inox. redondo Ø25cm, extraplano, cromado y antical.

Tubo salida techo de latón.

Mango ducha redondo.

Grifería monomando de latón cromado, 2 vías.

Presión máximo 6 at.mínimo 1 at.

Caudal medio 12 l/min.

Distribuidor de latón cromado.

Flexo reforzado PVC 1,5 m

Cartucho monomando 35mm.

SopORTE mango ducha con salida agua pared.

Precio : 215 €

IVA NO INCLUIDO



8 410201 535621





OLIMPO NEGRO MATE

SERIE

OLIMPO

SERIE

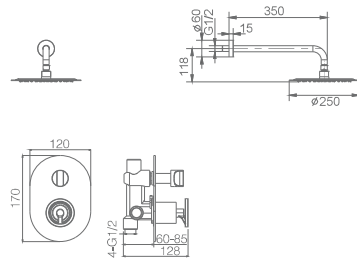

Ref. : GPC033/NG

Rociador de acero inox. redondo Ø25cm, extraplano, negro mate y antical.
Tubo salida pared de latón.
Mango ducha redondo.
Grifería monomando de latón negro mate, 2 vías.
Presión máximo 6 at.mínimo 1 at.
Caudal medio 12 l/min.
Distribuidor de latón negro mate.
Flexo reforzado PVC 1,5 m
Cartucho monomando 35mm.
Soporte mango ducha con salida agua pared.

Precio : 235 €
IVA NO INCLUIDO



VESUBIO

SERIE

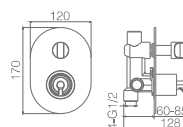
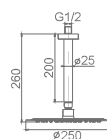

Ref. : GTV038/NG

Rociador de acero inox. redondo Ø25cm, extraplano, negro mate y antical.

Tubo salida techo de latón.

Mango ducha redondo.

Grifería monomando de latón negro mate, 2 vías.

Presión máximo 6 at.mínimo 1 at.

Caudal medio 12 l/min.

Distribuidor de latón negro mate.

Flexo reforzado PVC 1,5 m

Cartucho monomando 35mm.

SopORTE mango ducha con salida agua pared.

Precio : 235 €

IVA NO INCLUIDO





OLIMPO NEGRO ORO ROSA

SERIE



OLIMPO

SERIE

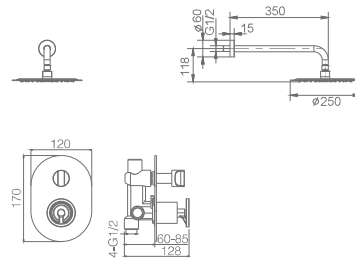

Ref. : GPC033/NOR

Rociador de acero inox. redondo Ø25cm, extraplano, oro rosa y antical.
Tubo salida pared de latón negro mate y oro rosa.
Mango ducha redondo.
Grifería monomando de latón negro mate y oro rosa, 2 vías.
Presión máximo 6 at.mínimo 1 at.
Caudal medio 12 l/min.
Distribuidor de latón negro mate y oro rosa.
Flexo reforzado PVC 1,5 m
Cartucho monomando 35mm.
Soporte mango ducha con salida agua pared.

Precio : 289 €
IVA NO INCLUIDO



VESUBIO

SERIE

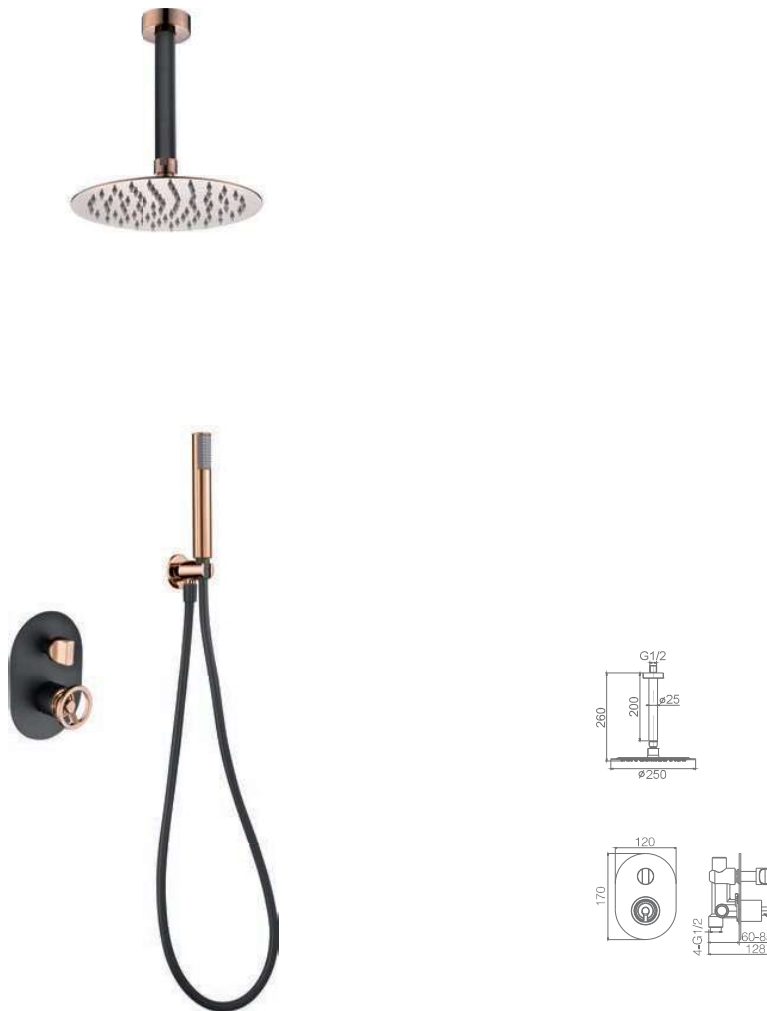

Ref. : GTV038/NOR

Rociador de acero inox. redondo Ø25cm, extraplano, oro rosa y antical.
Tubo salida techo de latón negro mate y oro rosa.
Mango ducha redondo.
Grifería monomando de latón negro mate y oro rosa, 2 vías.
Presión máximo 6 at.mínimo 1 at.
Caudal medio 12 l/min.
Distribuidor de latón negro mate y oro rosa.
Flexo reforzado PVC 1,5 m
Cartucho monomando 35mm.
Soporte mango ducha con salida agua pared.

Precio : 289 €
IVA NO INCLUIDO



SUECIA

SERIE

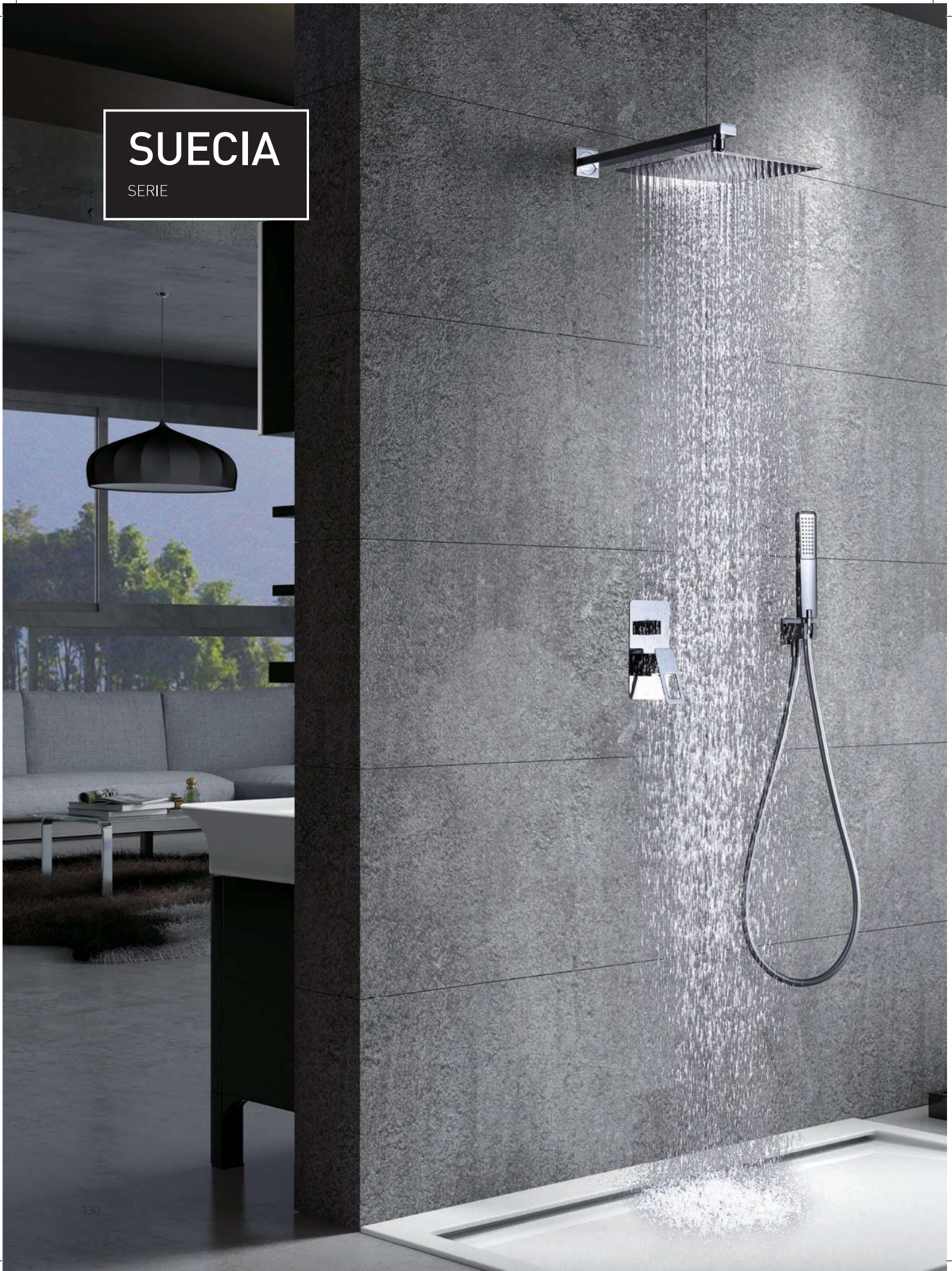



SUECIA

SERIE

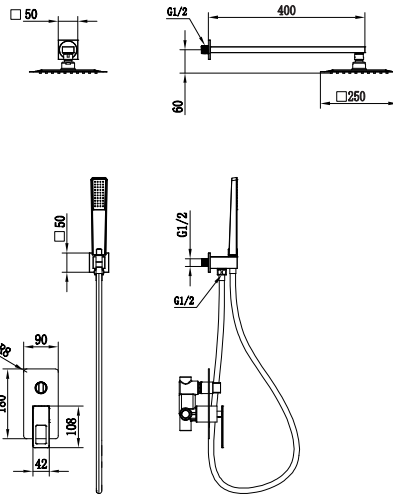

Ref. : BDC032-6/CR

Rociador de acero inox. Cuadrado 25X25cm, extraplano, cromado y antical.
Tubo salida pared de latón.
Mango ducha cuadrado.
Grifería monomando de latón cromado, de 2 vías.
Presión máximo 6 at.mínimo 1 at.
Caudal medio 12 l/min.
Distribuidor cuadrado de latón cromado.
Flexo reforzado PVC 1,5 m
Cartucho monomando 35mm.
Soporte mango ducha con salida agua pared.

Precio : 199 €

IVA NO INCLUIDO



ESTOCOLMO

SERIE



Ref. : BDES37-6/CR

Rociador de acero inox. Cuadrado 25X25cm, extraplano, cromado y antical.

Tubo salida techo de latón.

Mango ducha cuadrado.

Grifería monomando de latón cromado, de 2 vías.

Presión máximo 6 at.mínimo 1 at.

Caudal medio 12 l/min.

Distribuidor cuadrado de latón cromado.

Flexo reforzado PVC 1,5 m

Cartucho monomando 35mm.

Soporte mango ducha con salida agua pared.

Precio : 199 €
IVA NO INCLUIDO





SUECIA NEGRO MATE

SERIE



SUECIA

SERIE

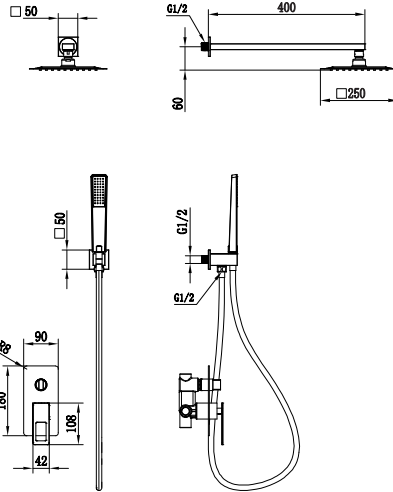

Ref. : BDC032-6/NG

Rociador de acero inox. Cuadrado 25X25cm, extraplano, negro mate y antical.
Tubo salida pared de latón.
Mango ducha cuadrado.
Grifería monomando de latón negro mate, de 2 vías.
Presión máximo 6 at.mínimo 1 at.
Caudal medio 12 l/min.
Distribuidor cuadrado de latón negro mate.
Flexo reforzado PVC 1,5 m
Cartucho monomando 35mm.
Soporte mango ducha con salida agua pared.

Precio : 209 €

IVA NO INCLUIDO



ESTOCOLMO

SERIE

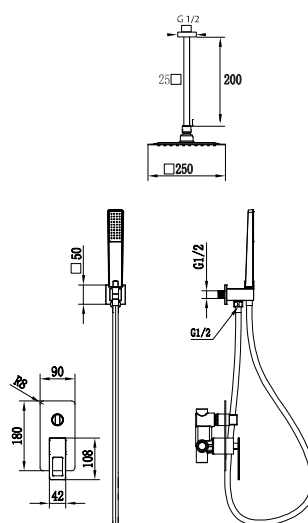

Ref. : BDES37-6/NG

Rociador de acero inox. Cuadrado 25X25cm, extraplano, negro mate y antical.

Tubo salida techo de latón.

Mango ducha cuadrado.

Grifería monomando de latón negro mate, de 2 vías.

Presión máximo 6 at.mínimo 1 at.

Caudal medio 12 l/min.

Distribuidor cuadrado de latón negro mate.

Flexo reforzado PVC 1,5 m

Cartucho monomando 35mm.

SopORTE mango ducha con salida agua pared.

Precio : 209 €

IVA NO INCLUIDO





SUECIA
NEGRO ORO ROSA

SERIE



SUECIA

SERIE

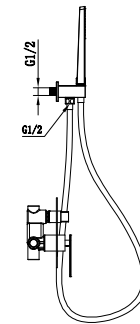
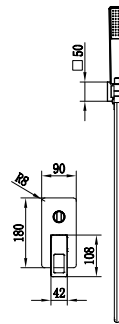
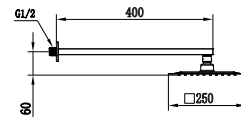
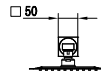

Ref. : BDC032-6/NOR

Rociador de acero inox. Cuadrado 25X25cm, extraplano, oro rosa y antical.
Tubo salida pared de latón negro mate y oro rosa.
Mango ducha cuadrado.
Grifería monomando de latón negro mate y oro rosa, de 2 vías.
Presión máximo 6 at.mínimo 1 at.
Caudal medio 12 l/min.
Distribuidor cuadrado de latón negro mate y oro rosa.
Flexo reforzado PVC 1,5 m
Cartucho monomando 35mm.
Soporte mango ducha con salida agua pared.

Precio : 224 €
IVA NO INCLUIDO



ESTOCOLMO

SERIE

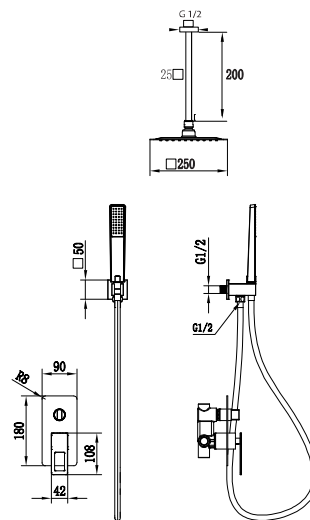

Ref. : BDES37-6/NOR

Rociador de acero inox. Cuadrado 25X25cm, extraplano, oro rosa y antical.

Tubo salida techo de latón negro mate y oro rosa.

Mango ducha cuadrado.

Grifería monomando de latón negro mate y oro rosa, de 2 vías.

Presión máximo 6 at.mínimo 1 at.

Caudal medio 12 l/min.

Distribuidor cuadrado de latón negro mate y oro rosa.

Flexo reforzado PVC 1,5 m

Cartucho monomando 35mm.

Soporte mango ducha con salida agua pared.

Precio : 224 €

IVA NO INCLUIDO



SUECIA NEGRO ORO

SERIE





SUECIA

SERIE

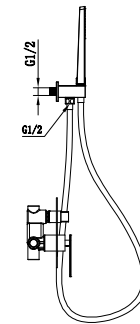
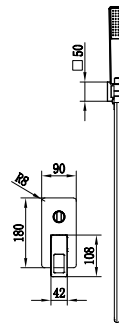
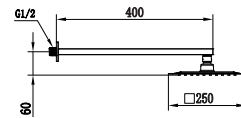
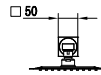

Ref. : BDC032-6/NGOLD

Rociador de acero inox. Cuadrado 25X25cm, extraplano, oro brillo y antical.
Tubo salida pared de latón negro mate y oro brillo.
Mango ducha cuadrado.
Grifería monomando de latón negro mate y oro brillo, de 2 vías.
Presión máximo 6 at.mínimo 1 at.
Caudal medio 12 l/min.
Distribuidor cuadrado de latón negro mate y oro brillo.
Flexo reforzado PVC 1,5 m
Cartucho monomando 35mm.
Soporte mango ducha con salida agua pared.

Precio : 224 €

IVA NO INCLUIDO



ESTOCOLMO

SERIE

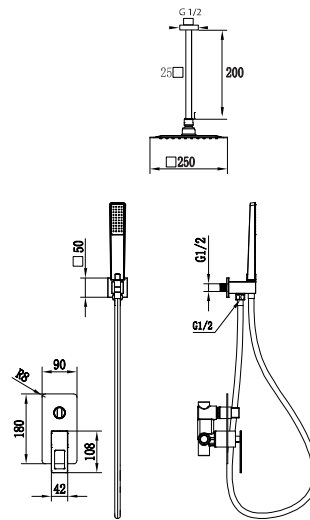

Ref. : BDES37-6/NGOLD

Rociador de acero inox. Cuadrado 25X25cm, extraplano, oro brillo y antical.

Tubo salida techo de latón negro mate y oro brillo.

Mango ducha cuadrado.

Grifería monomando de latón negro mate y oro brillo, de 2 vías.

Presión máximo 6 at.mínimo 1 at.

Caudal medio 12 l/min.

Distribuidor cuadrado de latón negro mate y oro brillo.

Flexo reforzado PVC 1,5 m

Cartucho monomando 35mm.

SopORTE mango ducha con salida agua pared.

Precio : 224 €
IVA NO INCLUIDO



SUECIA

SERIE



Ref. : **BDC032-4**

Grifería empotrada monomando latón.
Cromado
Box de registro.

Precio : **120 €**
IVA NO INCLUIDO

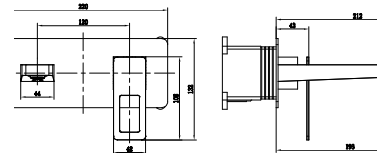

SUECIA

SERIE



Ref. : **BDC032-4NG**

Grifería empotrada monomando de latón.
Negro mate.
Box de registro.

Precio : **145 €**
IVA NO INCLUIDO

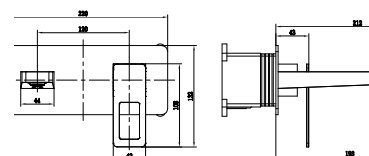

SUECIA

SERIE



Ref. : **BDC032-4NOR**

Grifería empotrada monomando de latón.
Negro mate, oro rosa.
Box de registro.

Precio : **151 €**

IVA NO INCLUIDO

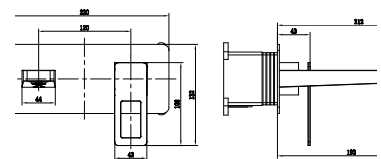

SUECIA

SERIE



Ref : **BDC032-4NGOLD**

Grifería empotrada monomando de latón.
Negro mate, oro brillo.
Box de registro.

Precio : **151 €**
IVA NO INCLUIDO

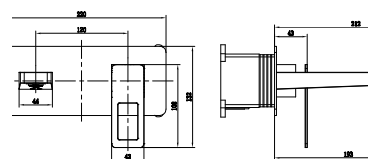

MALTA

SERIE

Ref. : **GLM021**

Grifería empotrada monomando
Laton cromado
Box de registro.
Rosca de 1/2" agregada al caño.
Cartucho 35mm.

Precio : **126 €**
IVA NO INCLUIDO



Grifería con
certificación

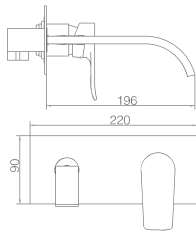

SUIZA

SERIE

Ref. : GLE020

Grifería empotrada monomando
Laton cromado
Box de registro.
Rosca 1/2" pieza independiente (machón)

Precio : 126 €
IVA NO INCLUIDO



Grifería con certificación

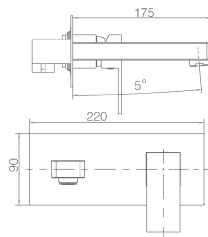

SUIZA NEGRO MATE

SERIE

Ref. : **GLE020/NG**

Grifería empotrada monomando
Latón negro
Box de registro.

Precio : **145 €**

IVA NO INCLUIDO



Grifería con
certificación

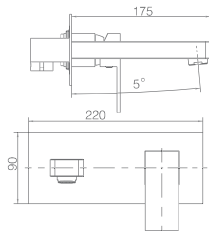

SUIZA BLANCO MATE

SERIE

Ref. : GLE020/BL

Grifería empotrada monomando
Latón blanco
Box de registro.

Precio : 145 €

IVA NO INCLUIDO



Grifería con
certificación

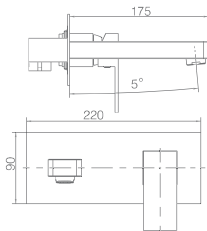



FIYI
SERIE



Ref. : **GLF016**

Grifería empotrada monomando
Latón cromado
En dos partes independientes.

Precio : **109 €**
IVA NO INCLUIDO

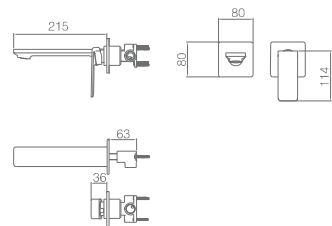



FIYI BLANCO MATE

SERIE

Ref. : **GLF016BL**

Grifería empotrada monomando.
Latón blanco mate.
En dos partes independientes.

Precio : **129 €**
IVA NO INCLUIDO

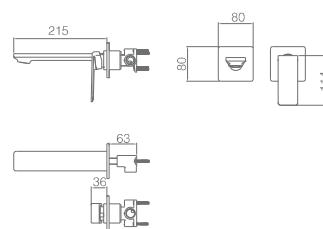



FIYI NEGRO MATE

SERIE

Ref. : **GLF016NG**

Grifería empotrada monomando.
Latón negro mate.
En dos partes independientes.

Precio : **129 €**
IVA NO INCLUIDO

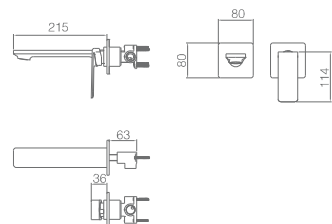



Ref. : **GLI019CR**

Grifería empotrada monomando
Latón cromado
En dos partes independientes.

Precio : **99 €**
IVA NO INCLUIDO

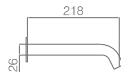

MILOS
SERIE



Ref. : **GLI019BL**

Grifería empotrada monomando.
Latón blanco mate.
En dos partes independientes.

Precio : **118 €**
IVA NO INCLUIDO

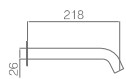

MILOS BLANCO MATE

SERIE



Ref. : **GLI019NG**

Grifería empotrada monomando.
Latón negro mate.
En dos partes independientes.

Precio : **118 €**
IVA NO INCLUIDO

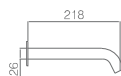

MILOS NEGRO MATE

SERIE



Ref. : **GLI019/NOR**

Grifería empotrada monomando.
Latón negro oro rosa.
En dos partes independientes.

Precio : **128 €**
IVA NO INCLUIDO



MILOS

NEGRO ORO ROSA

SERIE



ETNA

SERIE



Ref. : **GLT023**

Grifería empotrada monomando
Latón cromado.
En dos partes independientes.

Precio : **64 €**
IVA NO INCLUIDO

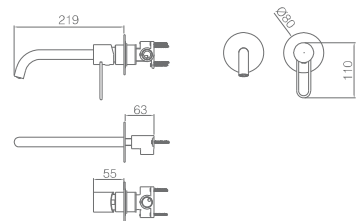

ETNA

NEGRO MATE

SERIE

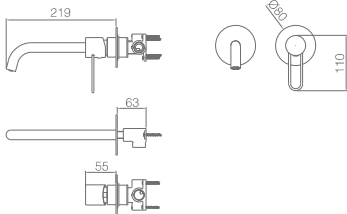

Ref. : GLT023/NG

Grifería empotrada monomando
Latón negro mate.
En dos partes independientes.

Precio : 70 €

IVA NO INCLUIDO







ETNA
BLANCO MATE
SERIE



Ref. : **GLT023/BL**

Grifería empotrada monomando
 Latón blanco mate.
 En dos partes independientes.

Precio : **70 €**
 IVA NO INCLUIDO

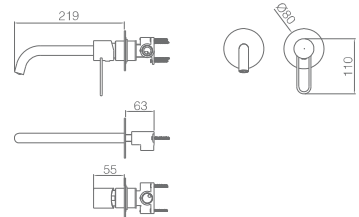

OLIMPO

SERIE





Ref. : **GLC033**

Grifería empotrada monomando
Laton cromado.
En dos partes independientes.

Precio : **110 €**

IVA NO INCLUIDO

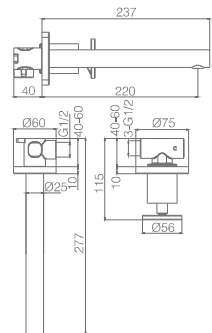



OLIMPO

SERIE



Ref. : **GLC033/NOR**

Grifería empotrada monomando
Negro mate y oro rosa.
En dos partes independientes.

Precio : **122 €**
IVA NO INCLUIDO

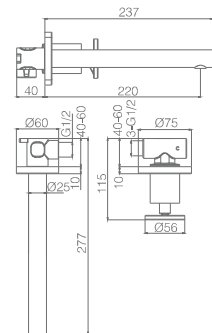



OLIMPO

SERIE

Ref. : **GLC033/NG**

Grifería empotrada monomando
Negro mate.
En dos partes independientes.

Precio : **121 €**
IVA NO INCLUIDO

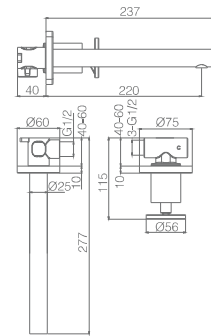

TERMOSTÁTICOS EMPOTRADOS



Ref. : GST22V (dos vías)
Grifería empotrada termostática, dos vías.
Latón cromado
Box de registro.
Cartucho termostático Vernet.

Precio : 139€
IVA NO INCLUIDO



Ref. : GST33V (tres vías)
Grifería empotrada termostática, tres vías.
Latón cromado
Box de registro.
Cartucho termostático TURN CLEAN SYSTEM.

Precio : 155 €
IVA NO INCLUIDO

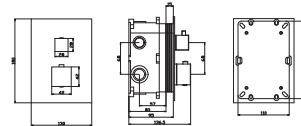

Ref. : GST44V (cuatro vías)
Grifería empotrada termostática, cuatro vías.
Latón cromado
Box de registro.
Cartucho termostático TURN CLEAN SYSTEM.

Precio : 189 €
IVA NO INCLUIDO

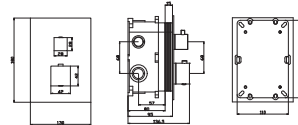

Ref. : GSP02V
Grifería empotrada termostática 2 vías.
Con pulsador.
Latón cromado
Box de registro.
Cartucho termostático TURN CLEAN SYSTEM.

Precio : 184 €
IVA NO INCLUIDO

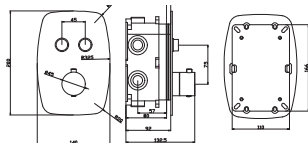

Ref. : CTP02V
Grifería empotrada termostática 2 vías.
Con pulsador.
Latón cromado
Box de registro.
Cartucho termostático TURN CLEAN SYSTEM.

Precio : 184 €
IVA NO INCLUIDO

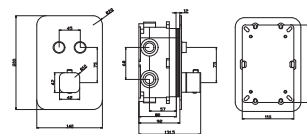

MONOMANDOS EMPOTRADOS



Ref. : GSM01V (una vía)
 Grifería empotrada monomando,
 1 vías
 Latón cromado
 Cartucho cerámico 35mm

Precio : 89 €
 IVA NO INCLUIDO

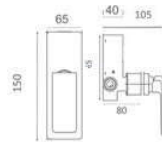

Ref. : GSM02V (dos vías)
 Grifería empotrada monomando,
 2 vías.
 Latón cromado
 Box de registro.
 Cartucho cerámico 35mm

Precio : 103 €
 IVA NO INCLUIDO

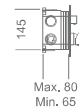

Ref. : GSM03V (tres vías)
 Grifería empotrada monomando,
 3 vías.
 Latón cromado
 Box de registro.
 Cartucho cerámico 35mm

Precio : 105 €
 IVA NO INCLUIDO

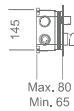

Ref. : GSM04V (cuatro vías)
 Grifería empotrada monomando,
 4 vías.
 Latón cromado
 Box de registro.
 Cartucho cerámico 35mm

Precio : 108 €
 IVA NO INCLUIDO

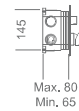

GRIFERÍA DE COCINA











TORINO

SERIE



Ref.: **GCE007**

Grifería monomando extraíble.
Cuerpo de grifería en Latón cromado.
Cartucho cerámico de 35 mm.
Latiguillos 50cm.

Precio: **139 €**

IVA NO INCLUIDO



Grifería con certificación

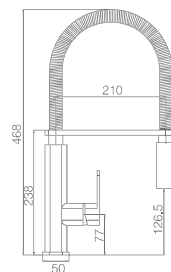



SAMOA

SERIE

Ref. : **GCE017**

Grifería monomando extraíble.
Cuerpo de grifería cromado.
Cartucho cerámico de 25 mm.
Latiguillos 50cm.

Precio: 121 €

IVA NO INCLUIDO

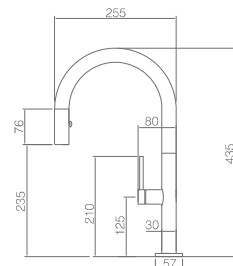



SAMOA BLANCO MATE

SERIE

Ref.: **GCE017/BL**

Grifería monomando extraíble.
Cuerpo de grifería blanco mate.
Cartucho cerámico de 25 mm.
Latiguillos 50cm.

Precio: **131 €**
IVA NO INCLUIDO

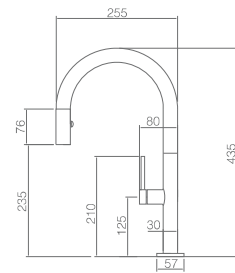



SAMOA NEGRO MATE

SERIE

Ref.: **GCE017/NG**

Grifería monomando extraíble.
Cuerpo de grifería negro mate.
Cartucho cerámico de 25 mm.
Latiguillos 50cm.

Precio: 131 €

IVA NO INCLUIDO

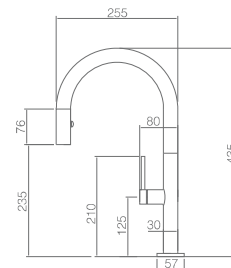



SAMOA

NEGRO ORO ROSA

SERIE

Ref.: **GCE017/NOR**

Grifería monomando extraíble.
Cuerpo de grifería negro oro rosa.
Cartucho cerámico de 25 mm.
Latiguillos 50cm.

Precio: **137 €**
IVA NO INCLUIDO

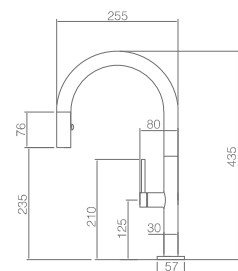





MENORCA

SERIE

Ref.: **GCE019**

Grifería monomando extraíble.
Cuerpo de grifería en Latón cromado.
Cartucho cerámico de 35 mm.
Latiguillos 50cm.

Precio: **125 €**
IVA NO INCLUIDO

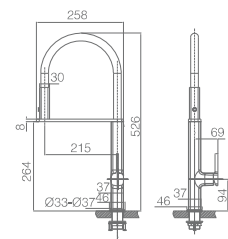

MENORCA

NEGRO MATE

SERIE



Ref.: **GCE019/NG**

Grifería monomando extraíble.
Cuerpo de grifería en Latón negro mate.
Cartucho cerámico de 35 mm.
Latiguillos 50cm.

Precio: **139 €**

IVA NO INCLUIDO

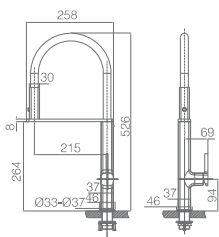





ITACA

SERIE



Ref.: **GCE018**

Grifería monomando plegable.
Cuerpo de grifería latón cromado.D
Cartucho cerámico de 25 mm.
Latiguillos 50cm.

Precio: **134 €**

IVA NO INCLUIDO

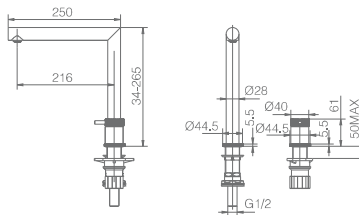

ITACA NEGRO MATE

SERIE

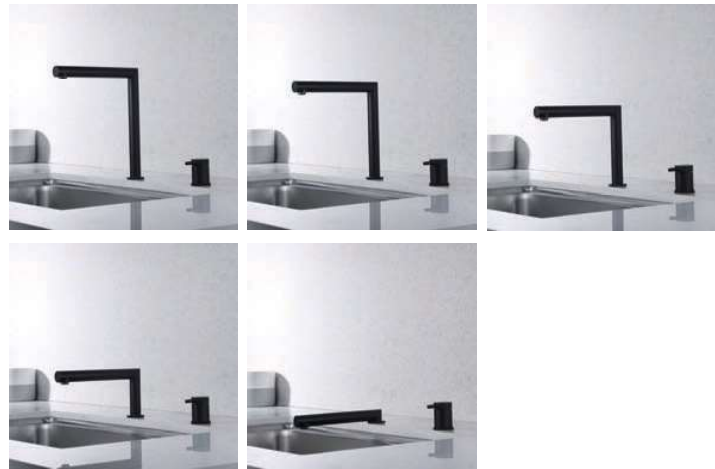

Ref.: **GCE018/NG**

Grifería monomando plegable.
Cuerpo de grifería latón negro mate.
Cartucho cerámico de 25 mm.
Latiguillos 50cm.

Precio: **139 €**

IVA NO INCLUIDO

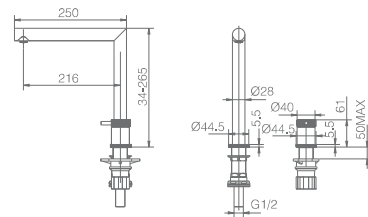

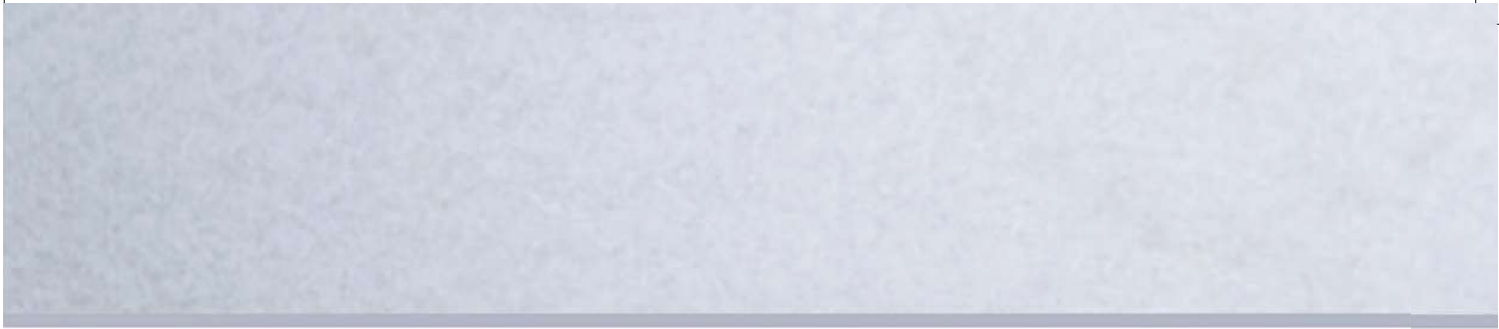



MANACOR

SERIE

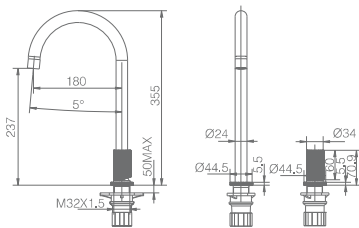

Ref.: **GCM001**

Grifería monomando.
Cuerpo de grifería latón cromado.
Cartucho cerámico de 25 mm.
Latiguillos 50cm.

Precio: **117 €**

IVA NO INCLUIDO



MANACOR

NEGRO MATE

SERIE



Ref. : **GCM001/NG**

Grifería monomando.
Cuerpo de grifería latón negro mate.
Cartucho cerámico de 25 mm.
Latiguillos 50cm.

Precio: 121 €

IVA NO INCLUIDO

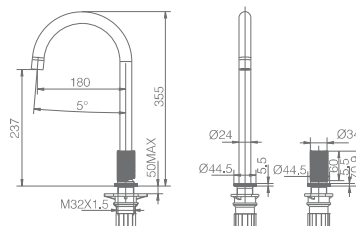

MANACOR BLANCO MATE

SERIE



Ref.: **GCM001/BL**

Grifería monomando.
Cuerpo de grifería latón blanco mate.
Cartucho cerámico de 25 mm.
Latiguillos 50cm.

Precio: **121 €**

IVA NO INCLUIDO

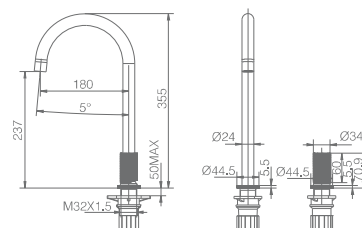



OLIMPO

SERIE



Ref.: **GCC033**

Grifería monomando.
Cuerpo de grifería latón cromado.
Cartucho cerámico de 25 mm.
Latiguillos 50cm.

Precio: **157 €**

IVA NO INCLUIDO

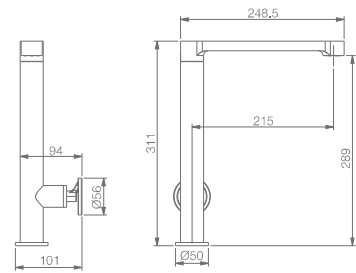

OLIMPO

NEGRO ORO ROSA

SERIE



Ref.: **GCC033/NOR**

Grifería monomando.
Cuerpo de grifería latón negro oro rosa.
Cartucho cerámico de 25 mm.
Latiguillos 50cm.

Precio: **175 €**

IVA NO INCLUIDO

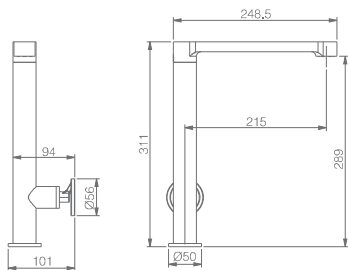





OLIMPO NEGRO MATE

SERIE



Ref.: **GCC033/NG**

Grifería monomando.
Cuerpo de grifería latón negro mate.
Cartucho cerámico de 25 mm.
Latiguillos 50cm.

Precio: **172 €**

IVA NO INCLUIDO

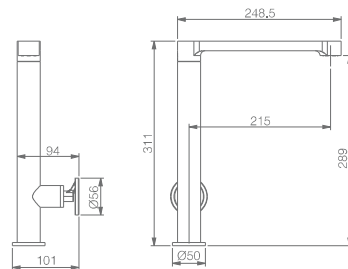

LANZAROTE

SERIE

Ref.: **GCE015**

Grifería monomando extraíble.
Cuerpo de grifería en Latón cromado.
Cartucho cerámico de 35 mm.
Latiguillos 50cm.



Precio: **129 €**
IVA NO INCLUIDO

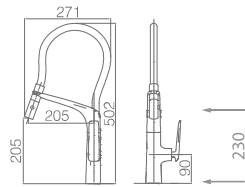





TOULOUSE

SERIE



Ref.: **GCE008**

Grifería monomando extraíble.
Cuerpo de grifería en Latón cromado.
Cartucho cerámico de 35 mm.
Latiguillos 50cm.

Precio: **158 €**

IVA NO INCLUIDO



Grifería con
certificación

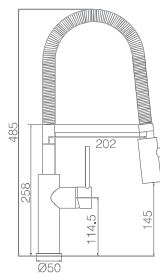

Flexible 50 cm

LAOS

SERIE

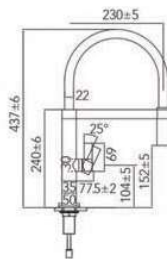

Altura mínima 37 cm



Ref.: GCE011

Grifería monomando extraíble.
Cuerpo de grifería en Latón cromado.
Cartucho cerámico Sedal de 25 mm.
Latiguillos 50cm.

Precio: 129 €
IVA NO INCLUIDO



Ref.: GCE012

Grifería monomando extraíble.
Cuerpo de grifería en negro mate.
Cartucho cerámico Sedal de 25 mm.
Latiguillos 50cm.

Precio: 150 €
IVA NO INCLUIDO



Ref.: GCE014

Grifería monomando extraíble.
Cuerpo de grifería en blanco mate.
Cartucho cerámico Sedal de 25 mm.
Latiguillos 50cm.

Precio: 130 €
IVA NO INCLUIDO







MALTA

SERIE



Ref.: **GCE006**

Grifería monomando extraíble.
Cuerpo de grifería cromado.
Cartucho cerámico de 35 mm.
Latiguillos 50cm.

Precio : **99 €**
IVA NO INCLUIDO



Grifería con
certificación

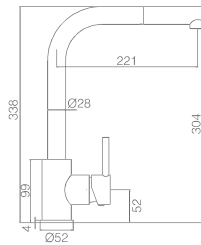

MALTA BLANCO MATE

SERIE

Ref.: **GCE006/BL**

Grifería monomando extraíble.
Cuerpo de grifería blanco mate.
Cartucho cerámico de 35 mm.
Latiguillos 50cm.

Precio: **115 €**
IVA NO INCLUIDO



Grifería con
certificación
ACS

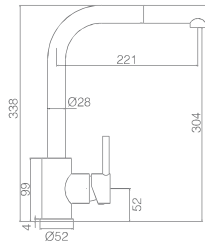





MALTA NEGRO MATE

SERIE

Ref.: **GCE006/NG**

Grifería monomando extraíble.
Cuerpo de grifería negro mate.
Cartucho cerámico de 35 mm.
Latiguillos 50cm.

Precio: **116 €**

IVA NO INCLUIDO



Grifería con
certificación

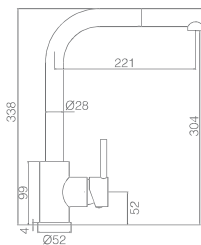

VENECIA

SERIE



Ref.: **GCE100**

Grifería monomando de cocina.
Cuerpo de grifería en Latón cromado.
Cartucho cerámico de 35 mm.
Latiguillos 50cm.

Precio: **79 €**
IVA NO INCLUIDO



Grifería con
certificación

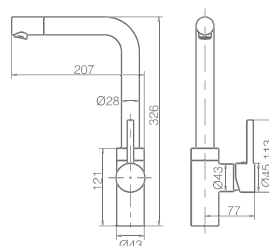





CONSTANZA

SERIE



Ref.: GCE005

Grifería monomando extraíble.
Cuerpo de grifería cromado.
Cartucho cerámico de 35 mm.
Latiguillos 50cm.

Precio: 149 €
IVA NO INCLUIDO

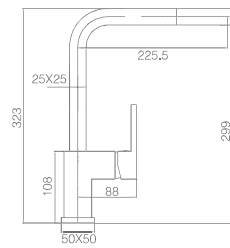

PIREO

SERIE



Ref.: **GOS003**

Grifería monomando de dos vías (osmosis)
Cuerpo de grifería en Latón cromado.
Cartucho cerámico de 35 mm.
Latiguillos 50cm.

Precio: **110 €**
IVA NO INCLUIDO



Grifería con
certificación

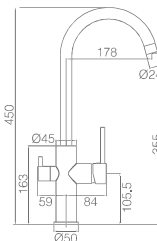

Osmosis



Osmosis



CAPRI

SERIE



Ref.: **GOS002**

Grifería monomando de dos vías (osmosis)
Cuerpo de grifería en Latón cromado.
Cartucho cerámico de 35 mm.
Latiguillos 50cm.

Precio: **136 €**
IVA NO INCLUIDO



Grifería con
certificación

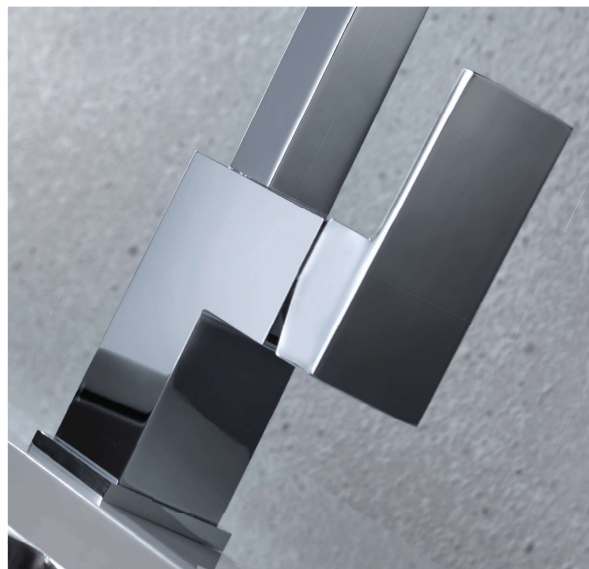
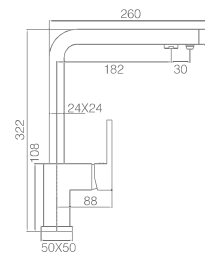

MONTECARLO

SERIE



Ref.: **GOS001**

Grifería monomando de dos vías (osmosis)
Cuerpo de grifería en Latón cromado.
Cartucho cerámico de 35 mm.
Latiguillos 50cm.

Precio: **129 €**
IVA NO INCLUIDO

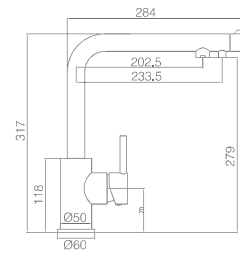

Osmosis



MARSELLA

SERIE



Ref.: **GOS004**

Grifería monomando de dos vías (osmosis)
Cuerpo de grifería en Latón cromado.
Cartucho cerámico de 35 mm.
Latiguillos 50cm.

Precio: **125 €**

IVA NO INCLUIDO

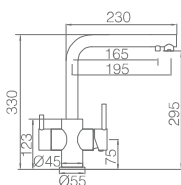

Osmosis





LYON

SERIE

Líneas simples y depuradas para un modelo que aúnan calidad y diseño.



Ref.: **GCR002**

Grifería monomando de cocina.
Cuerpo de grifería en Latón cromado.
Cartucho cerámico de 35 mm.
Latiguillos 50cm.

Precio: **53 €**

IVA NO INCLUIDO



Grifería con
certificación

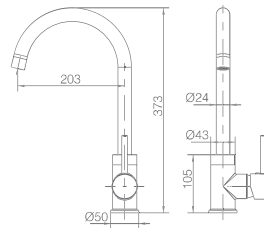

MIKONOS

SERIE



Ref.: **GCC002**

Grifería monomando de cocina.
Cuerpo de grifería en Latón cromado.
Giro 360°
Cartucho cerámico de 35 mm.
Latiguillos 50cm.

Precio: **159 €**
IVA NO INCLUIDO



Grifería con
certificación

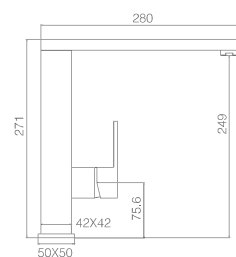





COX

SERIE



Ref.: **GCC001**

Grifería monomando de cocina.
Cuerpo de grifería en Latón cromado.
Cartucho cerámico de 35 mm.
Latiguillos 50cm.

Precio: **99 €**
IVA NO INCLUIDO



Grifería con
certificación

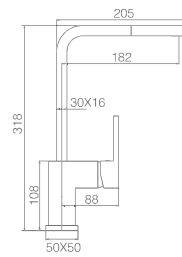

VERONA

SERIE

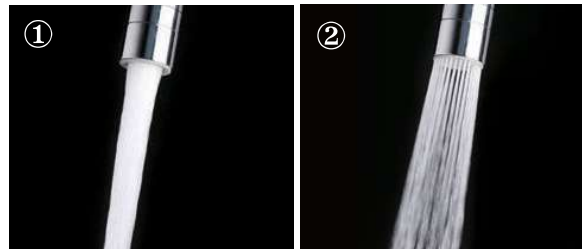

Ref.: **GCE010**

Grifería monomando de cocina.
Cuerpo de grifería en latón cromado y tubo flexible en negro mate.
Cartucho cerámico de 35 mm.
Aireador de dos posiciones.
Latiguillos 50 cm.

Precio: **72 €**
IVA NO INCLUIDO



Test de la grifería
aprobado

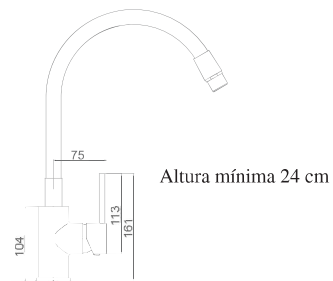



PROFESSIONAL
IMEX
DESIGN



VIENA

SERIE

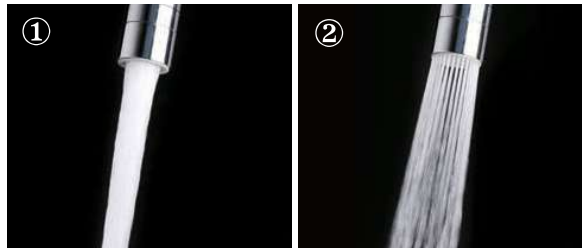

Ref.: **GCE009**

Grifería monomando de cocina.
Cuerpo de grifería en Latón cromado y
tubo flexible en blanco mate.
Cartucho cerámico de 35 mm.
Aireador de dos posiciones.
Latiguillos 50cm.

Precio: **72 €**
IVA NO INCLUIDO



Test de la grifería
aprobado

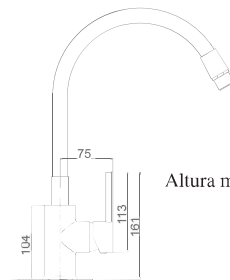

Altura mínima 24 cm



TOKYO

SERIE

Calidad y prestaciones dentro de un producto llevado a la máxima expresión. De gran utilidad son sus dos funciones de salida de agua que nos permiten aumentar la presión con un simple giro.

Ref.: **GCE016**

Grifería monomando de cocina.
Cuerpo de grifería en Latón cromado y tubo flexible en negro mate.
Cartucho cerámico de 35 mm.
Aireador de dos posiciones.
Latiguillos 50 cm.

Precio: **105 €**
IVA NO INCLUIDO



Test de la grifería
aprobado

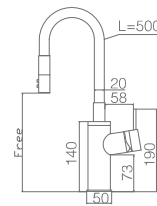

Altura máxima
recomendada 47 cm





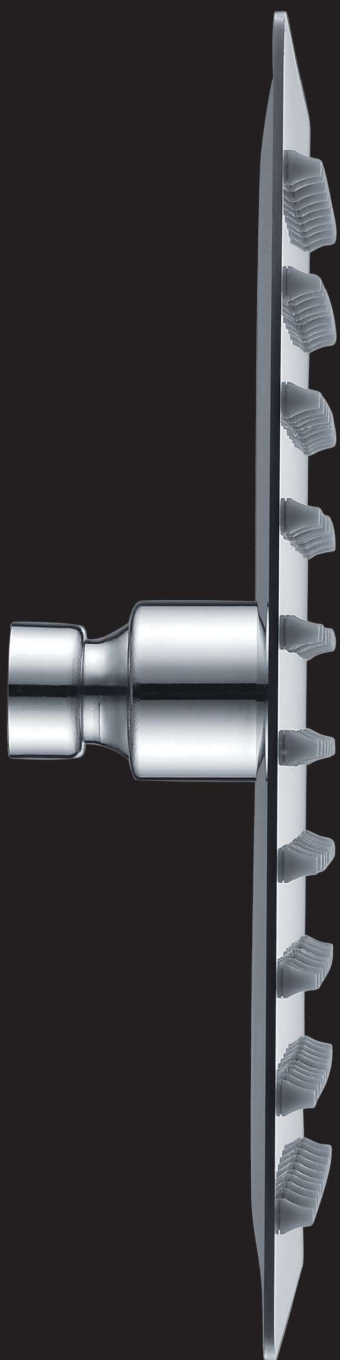

ROCIADORES

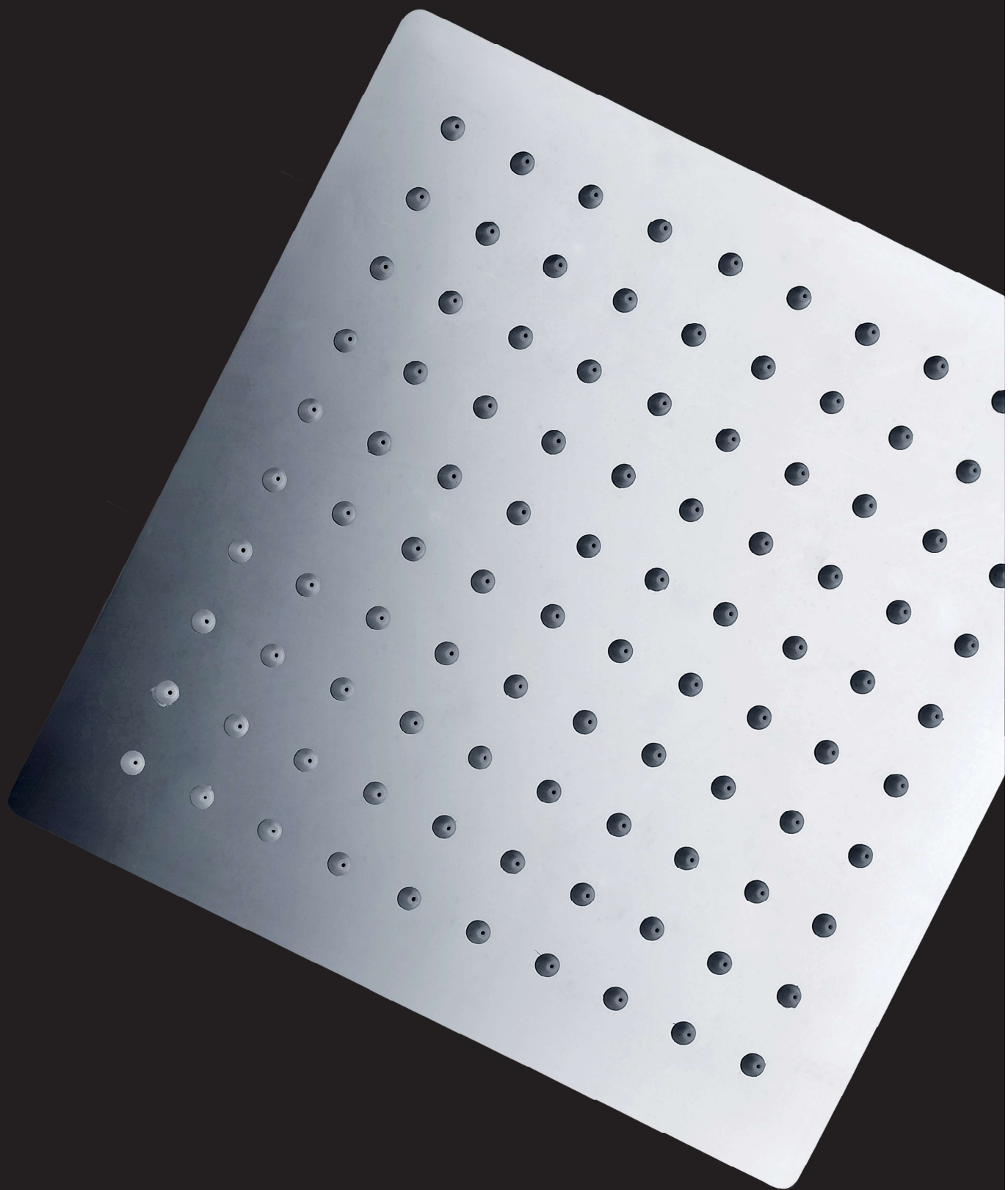

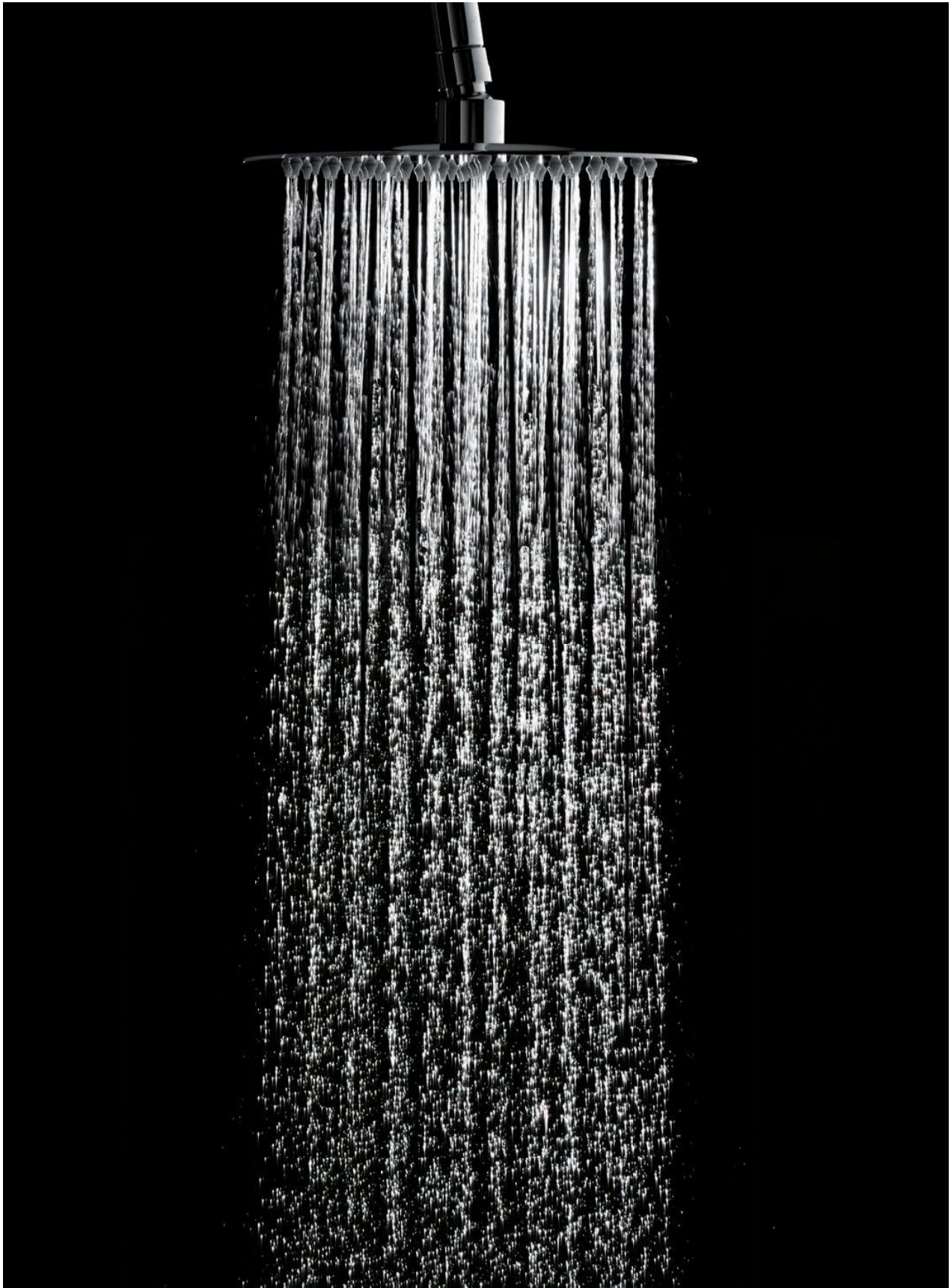



Ref.: RDN001

Dimensiones Ø20cm
Rociador Redondo Extraplano con
Material: Acero Inox S304
Acabado: Cromado

Precio: 20 €
IVA NO INCLUIDO



Ref.: RDN002

Dimensiones Ø30cm
Rociador Redondo Extraplano con
Material: Acero Inox S304
Acabado: Cromado

Precio: 44 €
IVA NO INCLUIDO



Ref.: RDN003

Dimensiones Ø25cm
Rociador Redondo Extraplano con
Material: Acero Inox S304
Acabado: Cromado

Precio: 34 €
IVA NO INCLUIDO



Ref.: RDN004

Dimensiones Ø40cm
Rociador Redondo Extraplano con
Material: Acero Inox S304
Acabado: Cromado

Precio: 89 €
IVA NO INCLUIDO





Ref.: RDC001
 Dimensiones 20X20cm
 Rociador Cuadrado Extraplano
 Material : Acero Inox S304
 Acababo : Cromado

Precio : 21 €
 IVA NO INCLUIDO



9 780201 373226



Ref.: RDC003
 Dimensiones 30X30cm
 Rociador Cuadrado Extraplano
 Material : Acero Inox S304
 Acababo : Cromado

Precio : 45 €
 IVA NO INCLUIDO



9 780201 373424



Premarco 30x30cm
Ref.: PTC030

Precio : 75 €
 IVA NO INCLUIDO



8 410201 169628

Premarco 30x30cm blanco
Ref.: PTC030/BL

Precio : 150 €
 IVA NO INCLUIDO



8 410201 319627

Premarco 30x30cm negro
Ref.: PTC030/NG

Precio : 150 €
 IVA NO INCLUIDO



8 410201 320623



Ref.: RDC002
 Dimensiones 25X25cm
 Rociador Cuadrado Extraplano
 Material : Acero Inox S304
 Acababo : Cromado

Precio : 35 €
 IVA NO INCLUIDO



9 780201 373325



Ref.: RDC004
 Dimensiones 40X40cm
 Rociador Cuadrado Extraplano
 Material : Acero Inox S304
 Acababo : Cromado

Precio : 90 €
 IVA NO INCLUIDO



9 780201 373523



Premarco 40x40cm
Ref.: PTC040

Precio : 85 €
 IVA NO INCLUIDO



8 410201 170624

Premarco 40x40cm blanco
Ref.: PTC040/BL

Precio : 170 €
 IVA NO INCLUIDO



8 410201 321620

Premarco 40x40cm negro
Ref.: PTC040/NG

Precio : 170 €
 IVA NO INCLUIDO



8 410201 322627

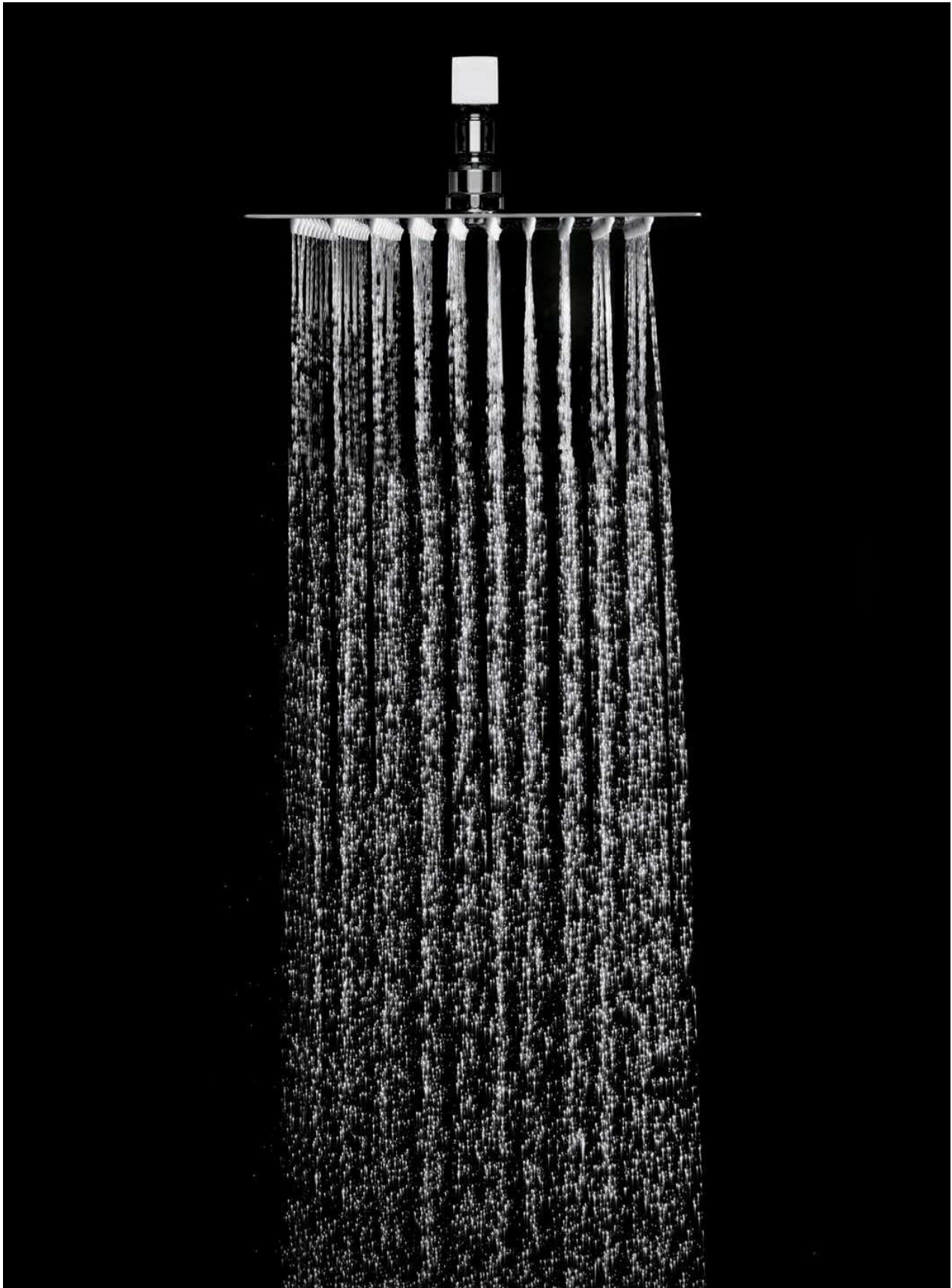



Ref.: **RDN001/BL**

Dimensiones Ø20cm
Rociador Redondo
Acababo : Blanco mate

Precio : **28 €**
IVA NO INCLUIDO



Ref.: **RDN001/NG**

Dimensiones Ø20cm
Rociador Redondo
Acababo : Negro mate

Precio : **28 €**
IVA NO INCLUIDO



Ref.: **RDN002/BL**

Dimensiones Ø25cm
Rociador Redondo
Acababo : Blanco mate

Precio : **40 €**
IVA NO INCLUIDO



Ref.: **RDN002/NG**

Dimensiones Ø25cm
Rociador Redondo
Acababo : Negro mate

Precio : **40 €**
IVA NO INCLUIDO



Ref.: **RDN003/BL**

Dimensiones Ø30cm
Rociador Redondo
Acababo : Blanco mate

Precio : **60 €**
IVA NO INCLUIDO



Ref.: **RDN003/NG**

Dimensiones Ø30cm
Rociador Redondo
Acababo : Negro mate

Precio : **60 €**
IVA NO INCLUIDO





Ref. : RDC001/BL

Dimensiones 20X20cm
Rociador Cuadrado
Acabado : Blanco mate

Precio : 32 €

IVA NO INCLUIDO



Ref. : RDC001/NG

Dimensiones 20X20cm
Rociador Cuadrado
Acabado : Negro mate

Precio : 32 €

IVA NO INCLUIDO



Ref. : RDC002/BL

Dimensiones 25X25cm
Rociador Cuadrado
Acabado : Blanco mate

Precio : 49 €

IVA NO INCLUIDO



Ref. : RDC002/NG

Dimensiones 25X25cm
Rociador Cuadrado
Acabado : Negro mate

Precio : 49 €

IVA NO INCLUIDO



Ref. : RDC003/BL

Dimensiones 30X30cm
Rociador Cuadrado
Acabado : Blanco mate

Precio : 65 €

IVA NO INCLUIDO



Ref. : RDC003/NG

Dimensiones 30X30cm
Rociador Cuadrado
Acabado : Negro mate

Precio : 65 €

IVA NO INCLUIDO



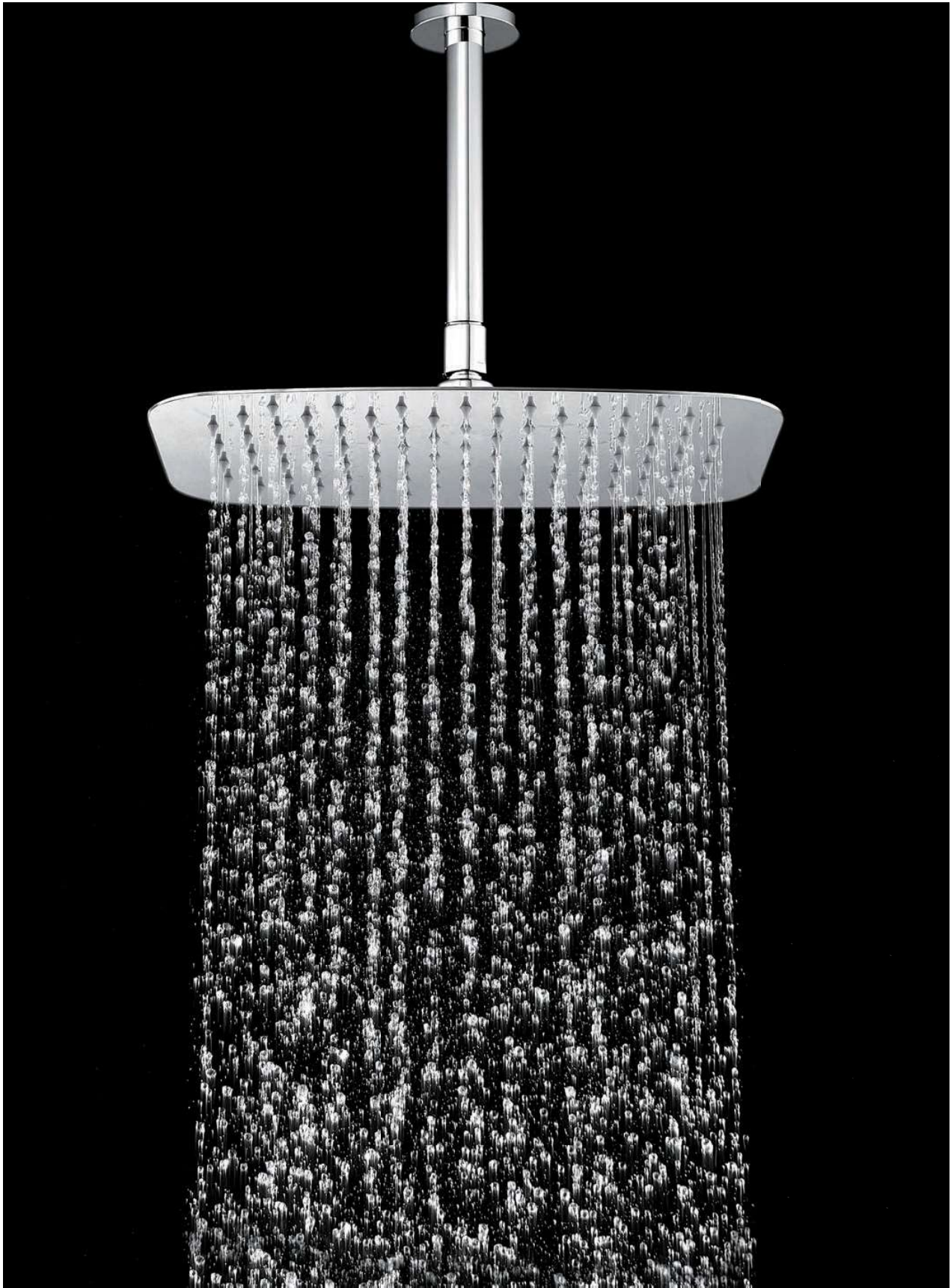

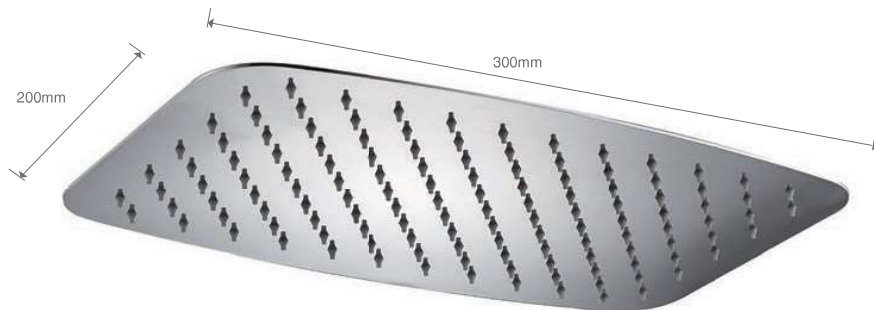

Ref. : RDR001

Dimensiones 20x30 cm
Rociador ovalado extraplano
Material : Acero Inox S304
Acabado : Cromado

Precio : 49 €
IVA NO INCLUIDO



Ref. : RDR002

Dimensiones 25x40 cm
Rociador ovalado extraplano
Material : Acero Inox S304
Acabado : Cromado

Precio : 54 €
IVA NO INCLUIDO



PROFESSIONAL
DESIGN
IMEX





Ref. : **RDF002**

Material : Acero Inox S304
Acabado : Cromado

Precio : **57 €**
IVA NO INCLUIDO



Ref. : **RDF003**

Material : Acero Inox S304
Acabado : Cromado

Precio : **129 €**
IVA NO INCLUIDO







Material : Acero Inox S304
 Acabado : Cromado
 Tres salidas
 Incluye premarco

Ref. : **RDG590**
 (dimensiones 59x48 cm)
 Sin premarco

Precio : **400 €**
 IVA NO INCLUIDO



Ref. : **RDG590/P**
 Con premarco (recomendado)

Precio : **505 €**
 IVA NO INCLUIDO

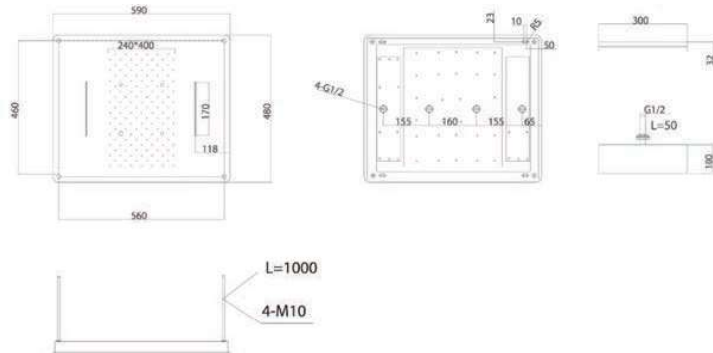

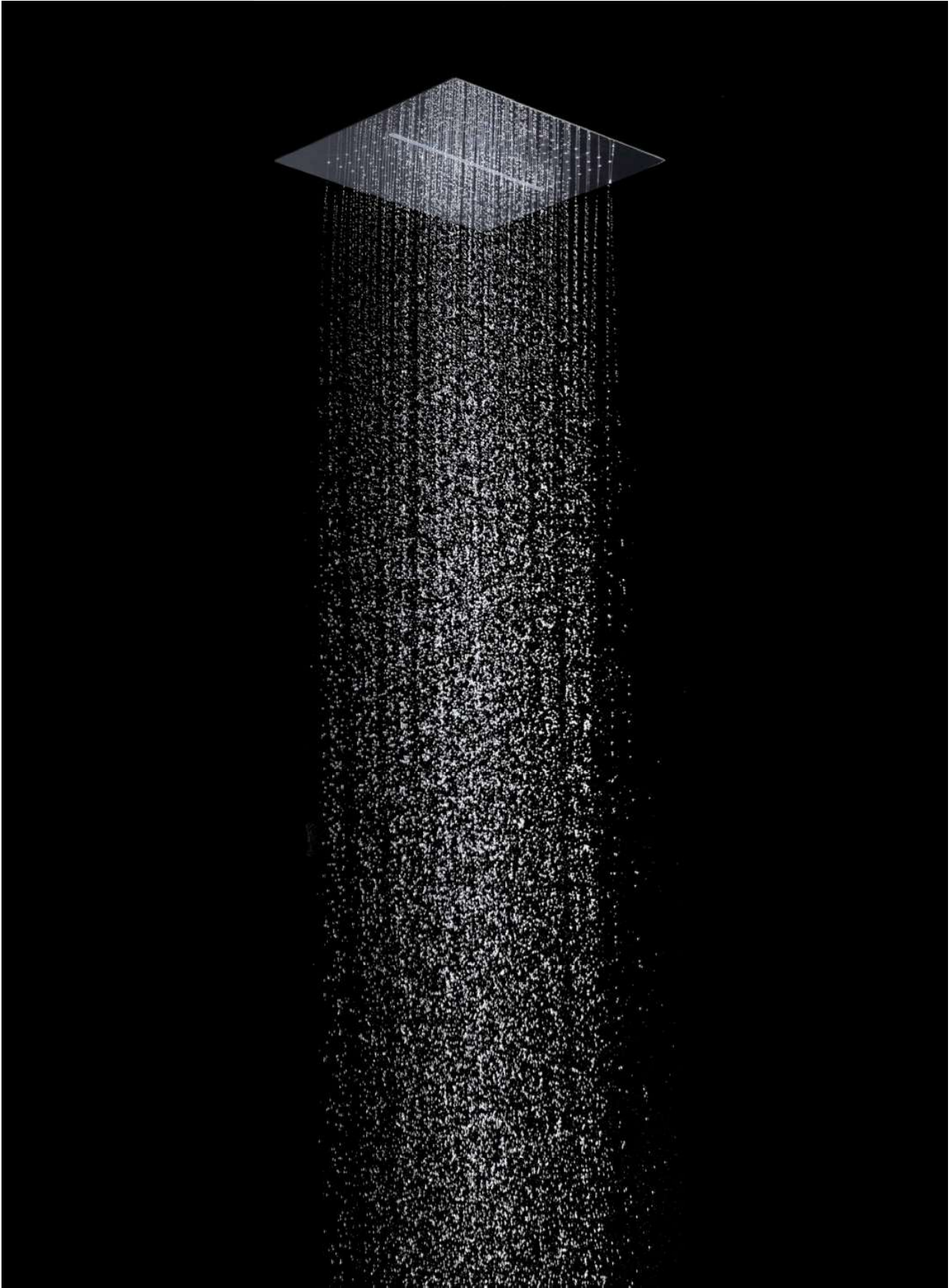

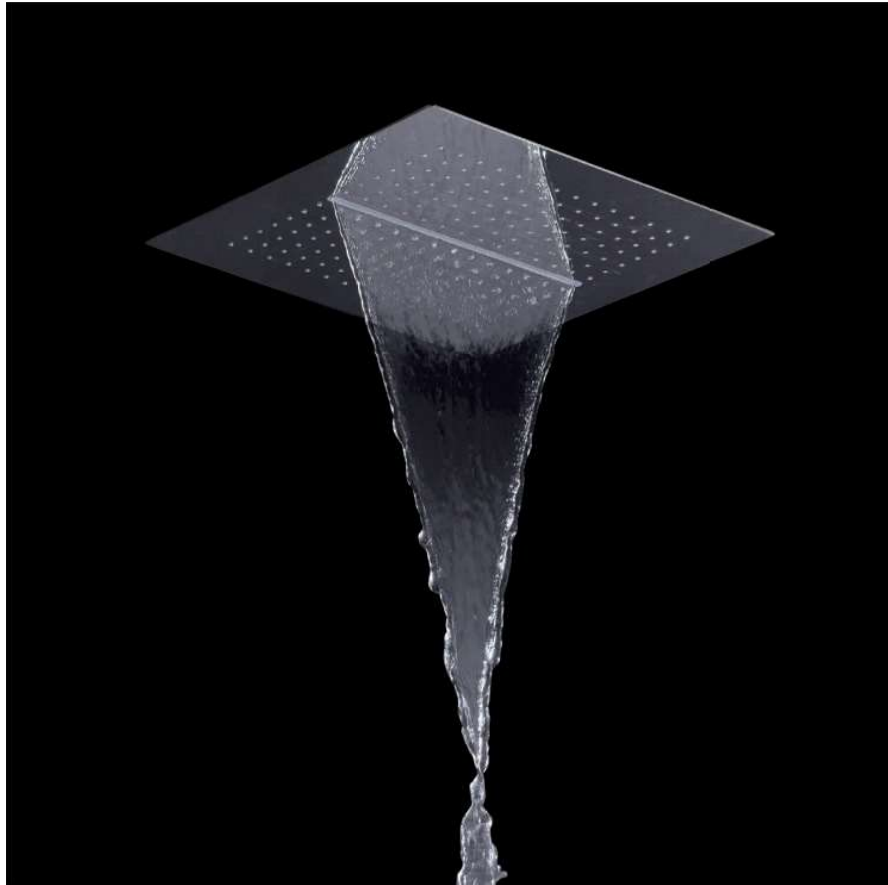

Ref.: **RDG400** (dimensiones 59x48 cm)

Material : Acero Inox 5304
Acabado : Cromado
Dos salidas
Incluye premarco

Precio : **285 €**
IVA NO INCLUIDO

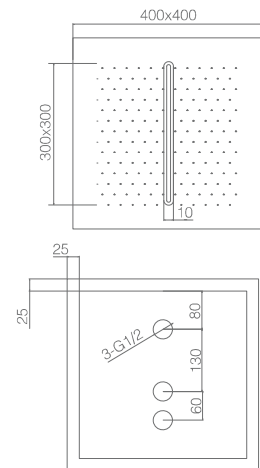





Ref. : RPS490

Material : Acero Inox S304
 Acabado : Cromado
 Rociador cuadrado salida pared
 2 funciones. Efecto lluvia y efecto cascada.

Precio : 419 €
 IVA NO INCLUIDO

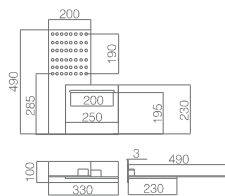

Ref. : RPS490/NG

Material : Acero Inox S304
 Acabado : Negro mate
 Rociador cuadrado salida pared
 2 funciones. Efecto lluvia y efecto cascada.

Precio : 448 €
 IVA NO INCLUIDO

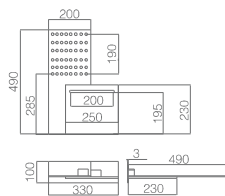

BIDÉS EMPOTRADOS

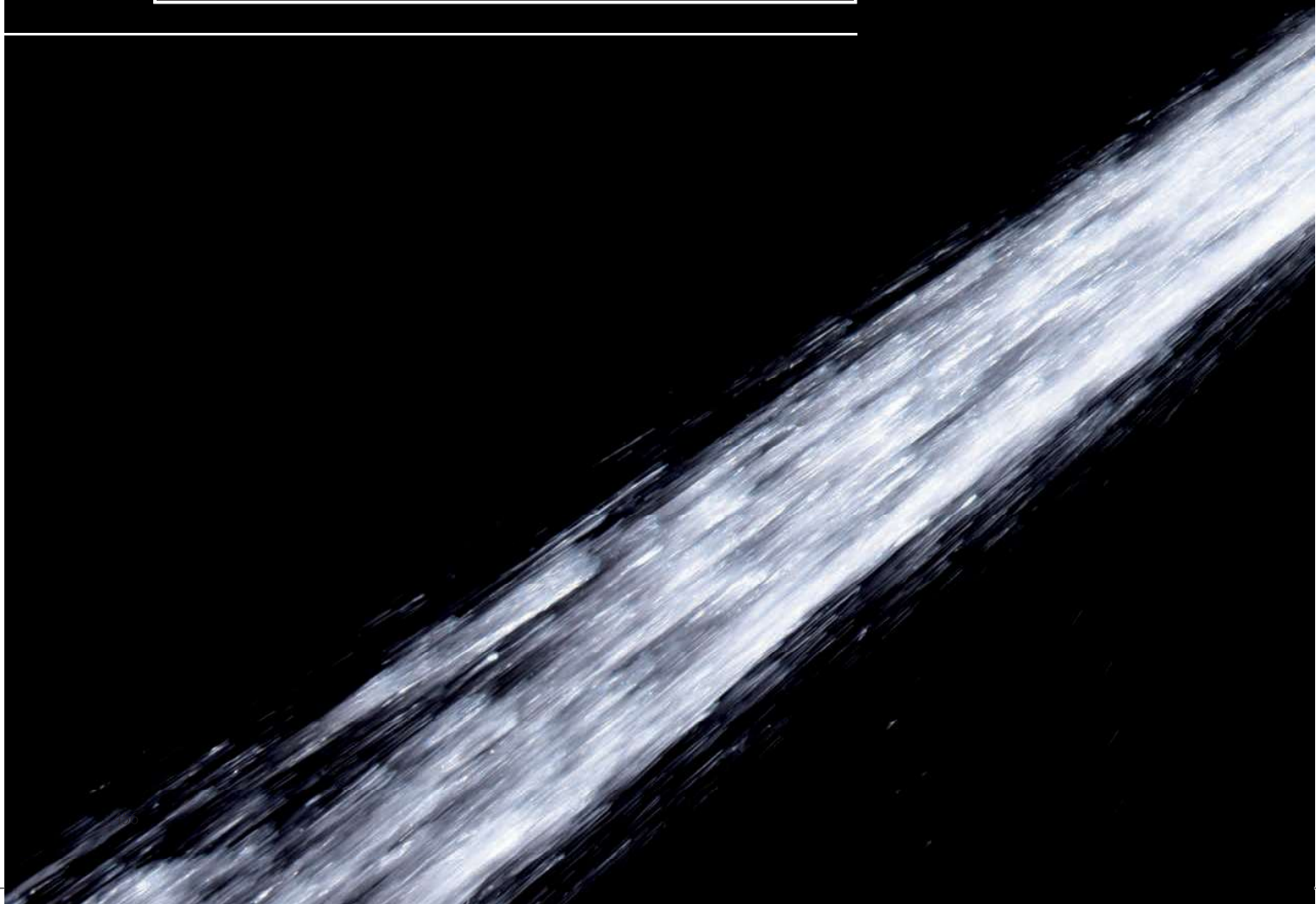





MUNICH

SERIE



Ref.: RDM001

Grifería empotrada de bidé.

Agua fría y caliente.

Mango de 1 posición.

Latón cromado.

Flexo de acero reforzado de 100 cm antiexplosión.

Tapón especial pre-montaje en latón cromado, alta resistencia.

Precio: 79 €

IVA NO INCLUIDO

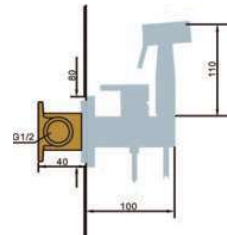

MUNICH NEGRO MATE

SERIE

Ref.: **RDM001/NG**

Grifería empotrada de bidé.

Agua fría y caliente.

Mango de 1 posición.

Latón negro mate.

Flexo de acero reforzado de 100 cm antiexplosión.

Tapón especial pre-montaje en latón cromado, alta resistencia.

Precio: **90 €**

IVA NO INCLUIDO

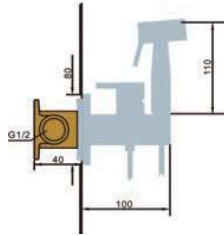





SUECIA

SERIE

Ref. : BDC032-5/CR

Grifería empotrada de bidé.
Agua fría y caliente.
Mango de 1 posición.
Latón cromado.
Flexo de acero reforzado de 100 cm antiexplosión.

Precio : 119 €
IVA NO INCLUIDO

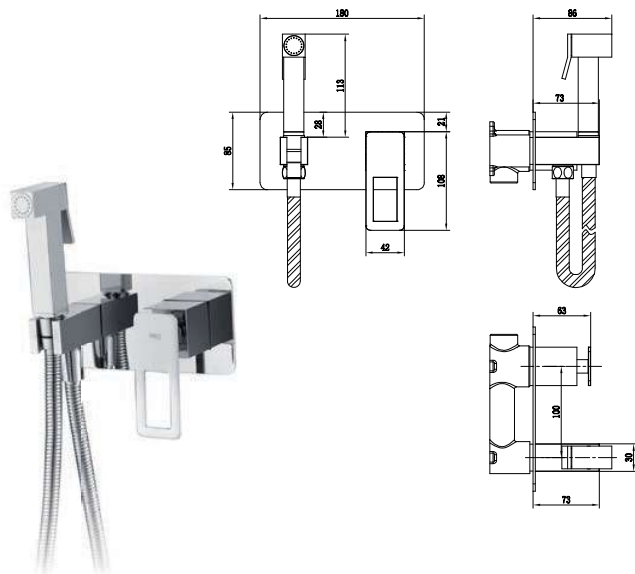



SUECIA

SERIE

Ref.: **BDC032-5/NG**

Grifería empotrada de bidé.
 Agua fría y caliente.
 Mango de 1 posición.
 Latón negro mate.
 Flexo de acero reforzado de 100 cm antiexplosión.

Precio: **129 €**

IVA NO INCLUIDO

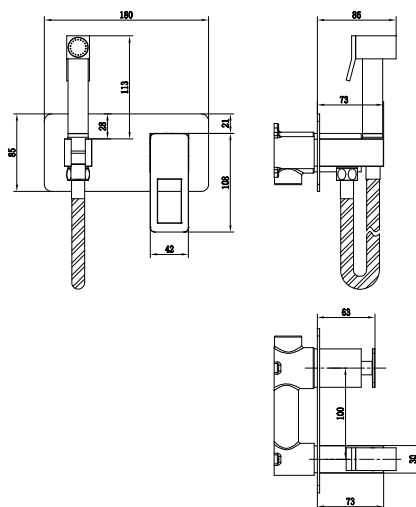

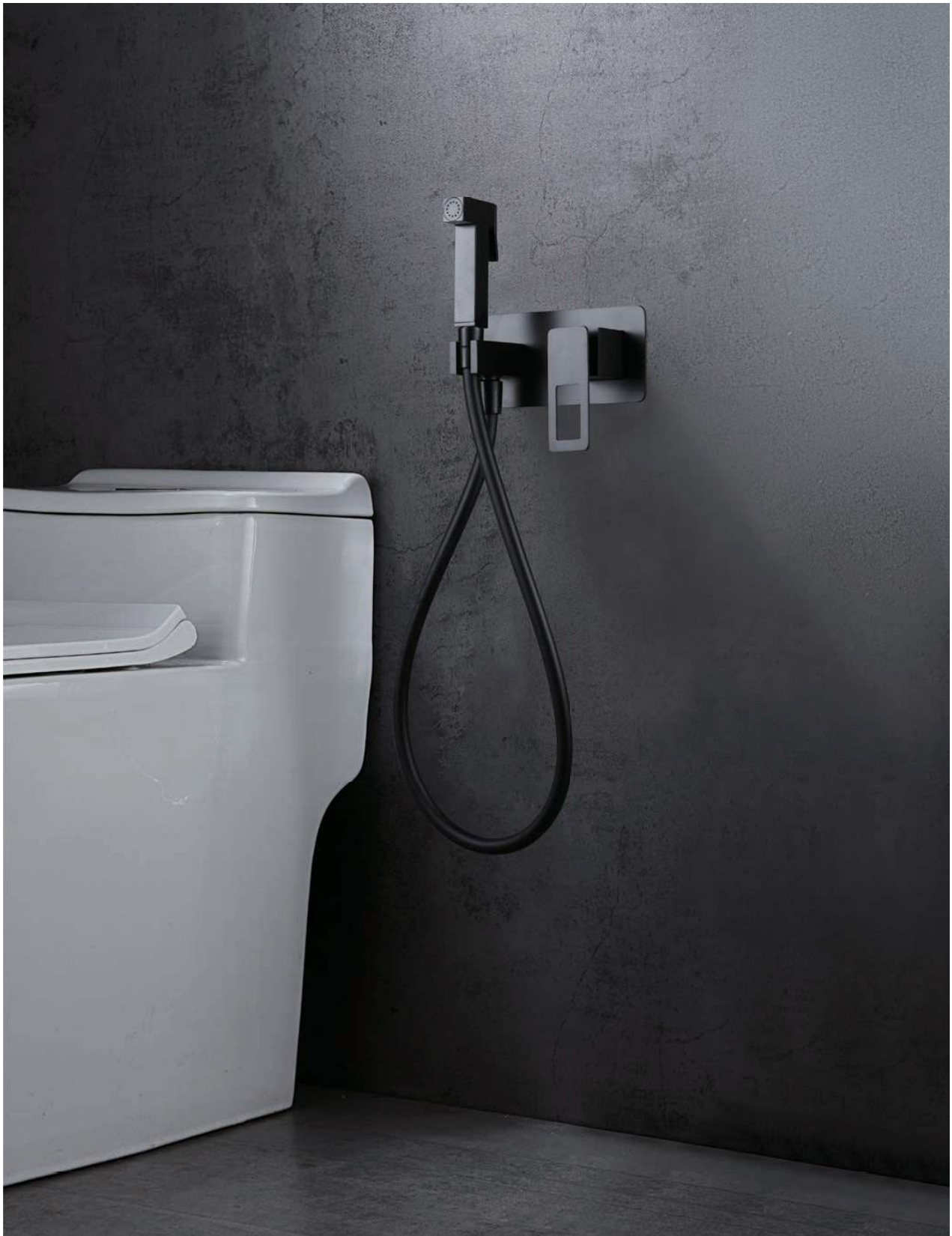



SUECIA

SERIE

Ref. : **BDC032-5/NOR**

Grifería empotrada de bidé.
Agua fría y caliente.
Mango de 1 posición.
Latón negro mate oro rosa.
Flexo de PVC de 100 cm.

Precio : **138 €**
IVA NO INCLUIDO

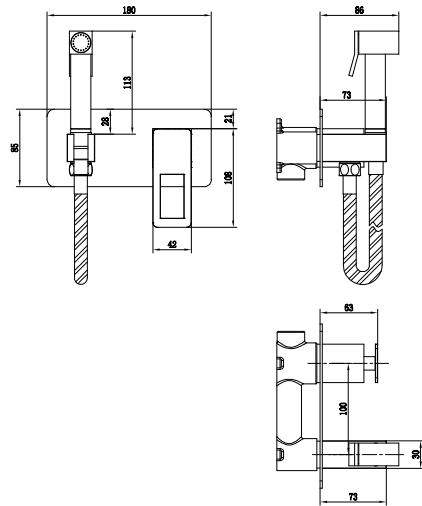



SUECIA

SERIE

Ref. : **BDC032-5/NGOLD**

Grifería empotrada de bidé.
 Agua fría y caliente.
 Mango de 1 posición.
 Latón negro mate oro brillo.
 Flexo de PVC de 100 cm.

Precio : **138 €**

IVA NO INCLUIDO

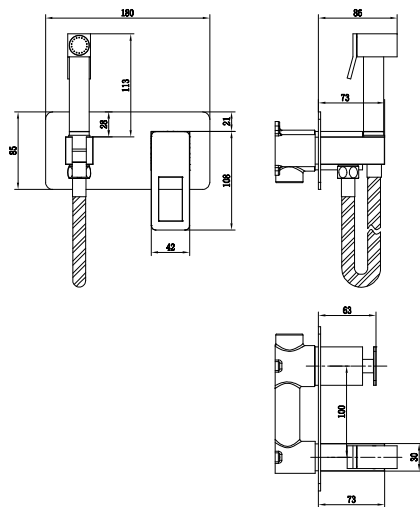





MAUI

SERIE



Ref. : **RDM004/CR**

Grifería empotrada de bidé.

Agua fría y caliente.

Mango de dos posiciones.

Latón cromado.

Flexo de acero reforzado de 100 cm antiexplosión.

Precio: **79 €**

IVA NO INCLUIDO

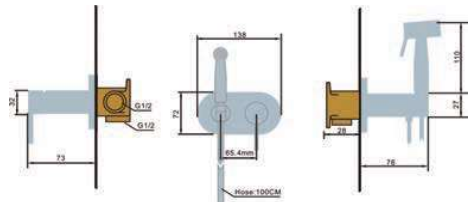



IRLANDA

SERIE



Ref. : **RDM003**

Grifería empotrada de bidé.

Agua fría y caliente.

Mango de 1 posición

Latón cromado.

Flexo de acero reforzado de 100 cm antiexplosión.

Precio : 120 €

IVA NO INCLUIDO



8 478023 772945

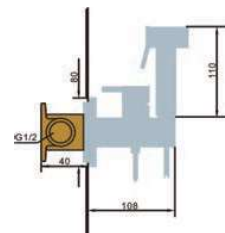

Conexion W.C.



NESS

SERIE

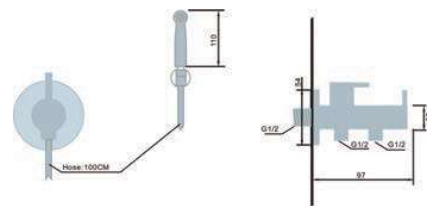

Conexion W.C.

Ref.: **RDM005**

Grifería empotrada de bidé.
Agua fría.
Mango dos posiciones.
Latón cromado.
Flexo acero reforzado de 100 cm.
Latiguillo de conexión al WC no incluido.

Precio: 41 €

IVA NO INCLUIDO



ACCESORIOS DE DUCHA



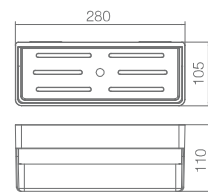

Ref.: **ABL006**

Material: PVC
Acabado: Blanco mate

Precio: **15,80€**
IVA NO INCLUIDO

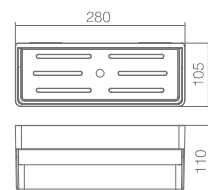

Ref.: **ANG005**

Material: PVC
Acabado: Negro mate

Precio: **15,80€**
IVA NO INCLUIDO





BARRA TOALLERO INTERIOR MUEBLE

Ref.: SPA001

Material : Acero
Acabado : Cromo

Precio : 19,90 €
IVA NO INCLUIDO

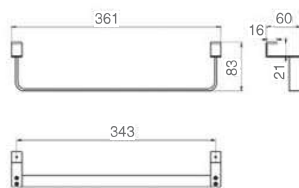

Ref.: SPA001/NG

Material : Acero
Acabado : negro mate

Precio : 26 €
IVA NO INCLUIDO





PROFESSIONAL
IMEX
DESIGN

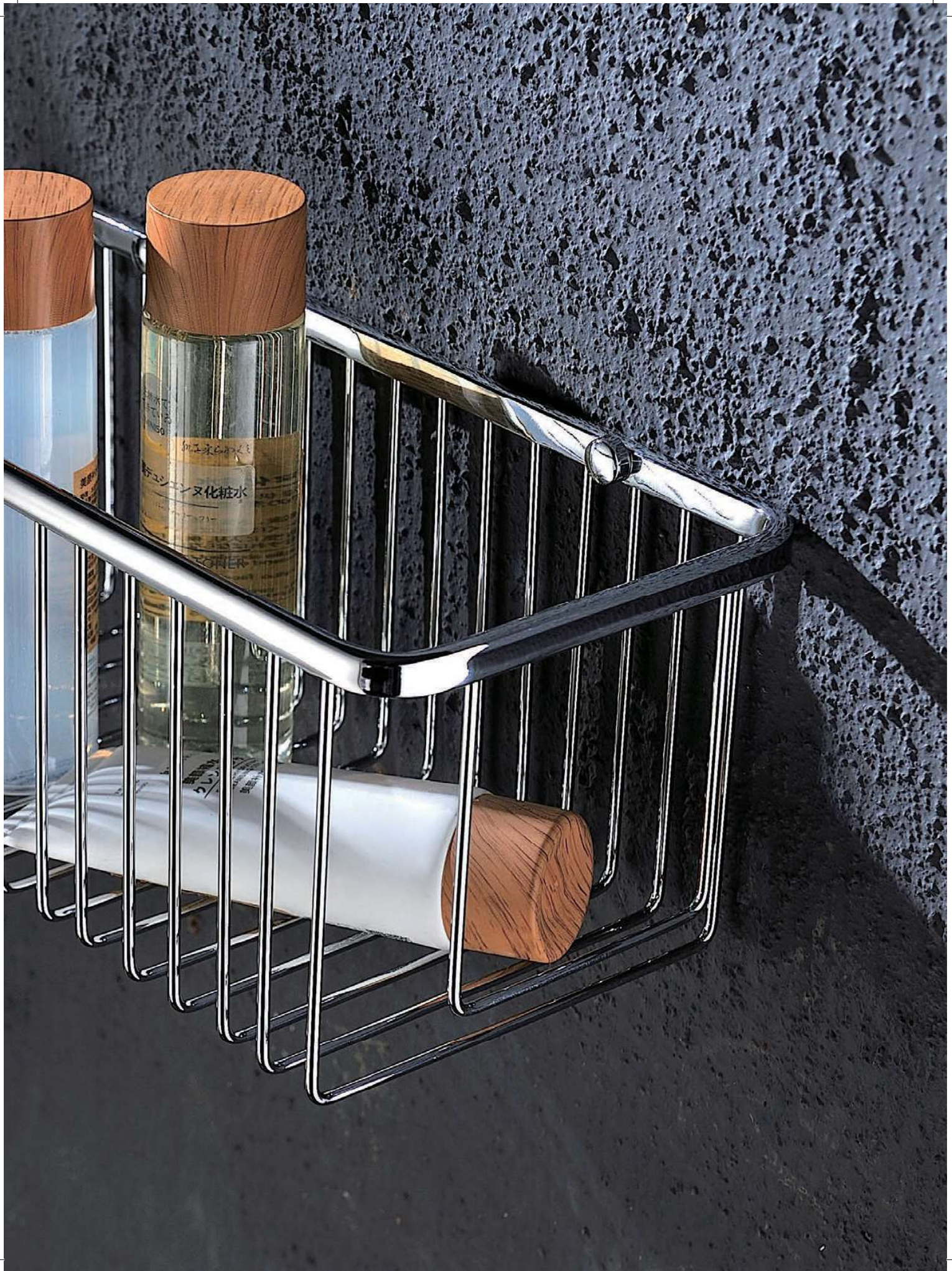

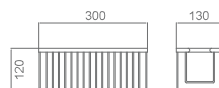

Ref.: **ADF002**

Material : Acero Inox S304
Acabado : Cromado

Precio : **35 €**
IVA NO INCLUIDO

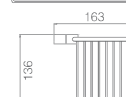
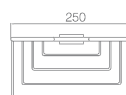

Ref.: **ADB001**

Material : Acero Inox S304
Acabado : Cromado

Precio : **49 €**
IVA NO INCLUIDO



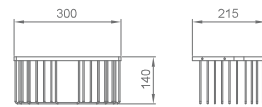

Ref. : **ADR001**

Material : Acero Inox 5304
Acabado : Cromado

Precio : **30 €**
IVA NO INCLUIDO





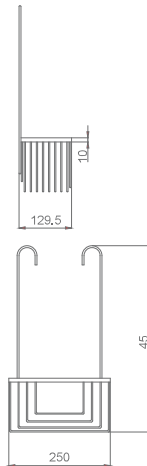

Ref.: ADG003 (PARA GRIFERIA)

Material : Acero Inox S304
Acabado : Cromado

Precio : 36 €
IVA NO INCLUIDO



Ref.: AAS004

Material : Latón
Acabado : Cromado

Precio : 19 €
IVA NO INCLUIDO



MANGOS DE DUCHA



AUSTIN

SERIE



Ref.: **MDA008/CR**

Modelo Austin cromado
Mangos de ducha 3 posiciones
Mango de ducha de ABS, ergonómico y antical.
Diámetro 12 cm

Precio: **14 €**

IVA NO INCLUIDO



Ref.: **MDA008/NG**

Modelo Austin, acabado negro mate.
Mangos de ducha 3 posiciones
Mango de ducha de ABS, ergonómico y antical.
Diámetro 12 cm

Precio: **17 €**

IVA NO INCLUIDO



Ref.: **MDA008/BL**

Modelo Austin, acabado blanco mate.
Mangos de ducha 3 posiciones
Mango de ducha de ABS, ergonómico y antical.
Diámetro 12 cm

Precio: **16 €**

IVA NO INCLUIDO



NEW YORK

SERIE



Ref.: **MDN009/CR**

Modelo New York
Mango de ducha con pulsador de 3 posiciones
Mango de ducha de ABS, ergonómico y antical
Diámetro 8 cm

Precio: **13 €**

IVA NO INCLUIDO



Ref.: **MDN009/NG**

Modelo New York, acabado negro mate.
Mango de ducha con pulsador de 3 posiciones
Mango de ducha de ABS, ergonómico y antical
Diámetro 8 cm

Precio: **17 €**

IVA NO INCLUIDO



Ref.: **MDN009/BL**

Modelo New York, acabado blanco mate.
Mango de ducha con pulsador de 3 posiciones
Mango de ducha de ABS, ergonómico y antical
Diámetro 8 cm

Precio: **16 €**

IVA NO INCLUIDO



HENK

SERIE



Ref.: **MDH013**

Modelo Henk cromado
Mangos de ducha 1 posición.
Mango de ducha de ABS, ergonómico y antical.

Precio : **7 €**
IVA NO INCLUIDO



Ref.: **MDH013/NG**

Modelo Henk negro
Mangos de ducha 1 posición.
Mango de ducha de ABS, ergonómico y antical.

Precio : **8 €**
IVA NO INCLUIDO



Ref.: **MDH013/BL**

Modelo Henk blanco
Mangos de ducha 1 posición.
Mango de ducha de ABS, ergonómico y antical.

Precio : **8 €**
IVA NO INCLUIDO



GENOVA

SERIE



Ref.: **MDV014**

Modelo Génova
Mango de ducha con pulsador de 1 posición.
Mango de ducha de ABS, ergonómico y antical

Precio: **7 €**
IVA NO INCLUIDO



Ref.: **MDV014/NG**

Modelo Génova
Mango de ducha con pulsador de 1 posición.
Mango de ducha de ABS, ergonómico y antical

Precio: **8 €**
IVA NO INCLUIDO



Ref.: **MDV014/BL**

Modelo Génova
Mango de ducha con pulsador de 1 posición.
Mango de ducha de ABS, ergonómico y antical

Precio: **8 €**
IVA NO INCLUIDO



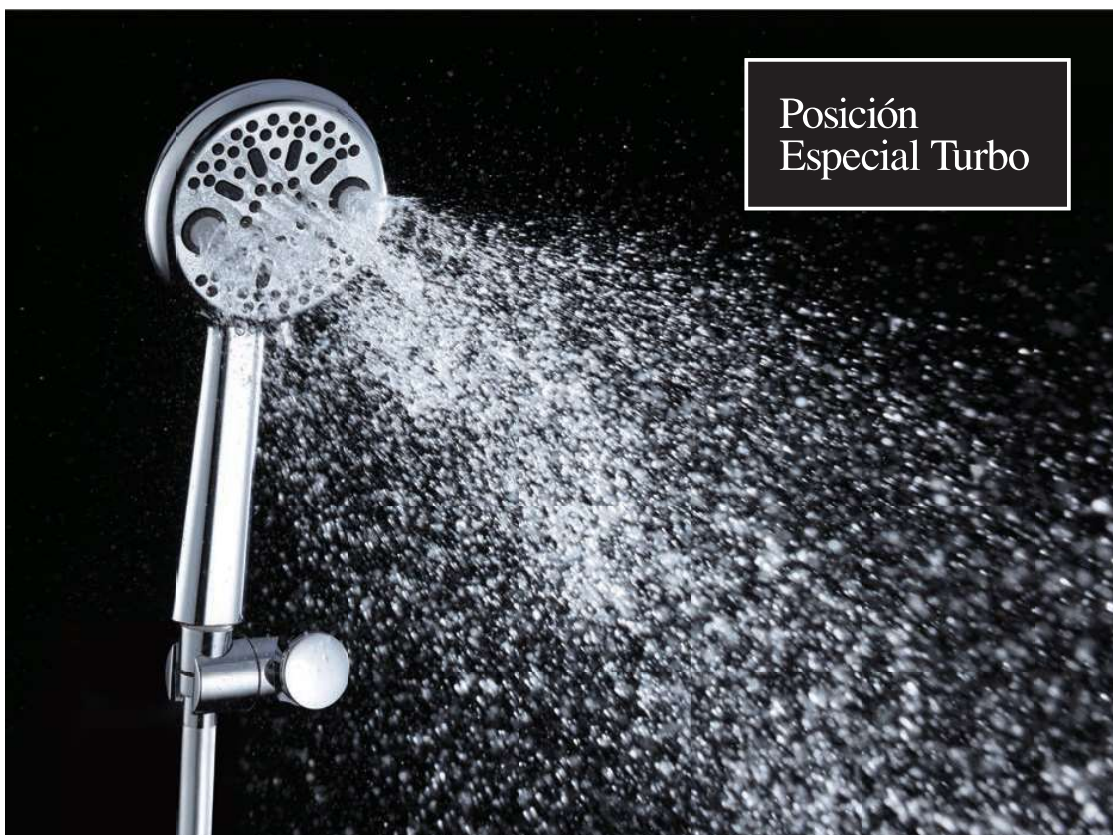



KANSAS

SERIE

Ref.: **MDK011**

Modelo Kansas
Mango de ducha con pulsador de 2 posiciones,
de ABS, ergonómico y antical

Precio: **12 €**
IVA NO INCLUIDO



NEVADA

SERIE

Ref.: **MDN012**

Modelo Nevada
Mango de ducha 4 posiciones de ABS,
ergonómico y antical
Diámetro 8,5 cm

Precio: **12 €**
IVA NO INCLUIDO





Ref.: MDD010

Modelo Denver
Mangos de ducha 3 posiciones
Mango de ducha de ABS,
ergonómico y antical
Diámetro 10 cm

Precio: 4.3 €
IVA NO INCLUIDO



Ref.: MDM006

Modelo Miami
Mangos de ducha 3 posiciones
Mango de ducha de
ABS,ergonómico y antical
Diámetro 10 cm

Precio: 8.50 €
IVA NO INCLUIDO



Ref.: MDG004

Modelo Houston
Mangos de ducha 3 posiciones.
Mango de ducha de
ABS,ergonómico y antical
Diámetro 9,5 cm

Precio: 5.90 €
IVA NO INCLUIDO





Ref.: MDC003

Modelo Orlando
Mangos de ducha 2 posiciones.
Mango de ducha de
ABS,ergonómico y antical
Diámetro 9,5 cm

Precio: 6.50 €
IVA NO INCLUIDO



9 780201 374629



Ref.: MDL005

Modelo Chicago
Mangos de ducha 5 posiciones.
Mango de ducha de
ABS,ergonómico y antical
Diámetro 8,5 cm

Precio: 6.60 €
IVA NO INCLUIDO



9 780201 374627



Ref.: MDB002

Modelo Boston.
Mangos de ducha 1 posición
Mango de ducha de
ABS,ergonómico y antical
Diámetro 10 cm

Precio: 4.80 €
IVA NO INCLUIDO



9 780201 374620



Ref.: MDL001

Modelo Dallas
Mangos de ducha 1 posición
Mango de ducha de
ABS,ergonómico y antical
Diámetro 6 cm

Precio: 4.90 €
IVA NO INCLUIDO



9 780201 374421

VÁLVULAS DE CLICK CLACK Y COMPLEMENTOS



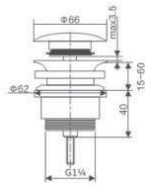

Ref. : VCC007(blanco mate)

Apta para todos los lavabos y bidés, con o sin rebosadero.
Sistema de apertura/cierre garantizado para ciclos de 20.000 usos.
Rosca inferior de 1 1/4.
Sistema antical.
Fabricadas en latón, blanco mate integral.
Montaje rápido y sencillo.

Precio : 13,50 €

IVA NO INCLUIDO

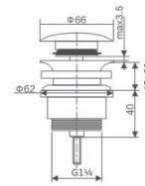

Ref. : VCC003(cerámica blanco brillo)

Apta para todos los lavabos y bidés, con o sin rebosadero.
Sistema de apertura/cierre garantizado para ciclos de 20.000 usos.
Rosca inferior de 1 1/4.
Sistema antical.
Fabricadas en latón, cromado, con tapa cerámica blanca.
Montaje rápido y sencillo.

Precio : 13.50 €

IVA NO INCLUIDO

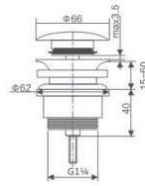

Ref. : VCC008(negro mate)

Apta para todos los lavabos y bidés, con o sin rebosadero.
Sistema de apertura/cierre garantizado para ciclos de 20.000 usos.
Rosca inferior de 1 1/4.
Sistema antical.
Fabricadas en latón, negro mate.
Montaje rápido y sencillo.

Precio : 13,50 €

IVA NO INCLUIDO

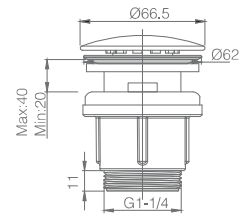

Ref. : VCC009

Apta para todos los lavabos y bidés, con o sin rebosadero.
Sistema de apertura/cierre garantizado para ciclos de 20.000 usos.
Rosca inferior de 1 1/4.
Sistema antical.
Fabricadas en PVC y acero S304, cromado.
Montaje rápido y sencillo.

Precio : 7.5 €

IVA NO INCLUIDO

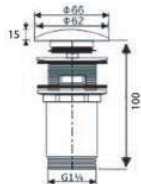

Ref. : VCC010

Apta para todos los lavabos de sobremesa tipo bol.
Sistema de apertura/cierre garantizado para ciclos de 20.000 usos.
Rosca inferior de 1 1/4.
Sistema antical.
Fabricadas en latón, cromado.
Montaje rápido y sencillo.
Sin rebosadero.

Precio : 8 €

IVA NO INCLUIDO



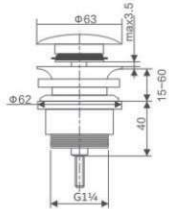

Ref. : VCC001

Apta para todos los lavabos y bidés, con o sin rebosadero.
Sistema de apertura/cierre garantizado para ciclos de 20.000 usos.
Rosca inferior de 1 1/4.
Sistema antical.
Fabricadas en latón,cromado.
Montaje rápido y sencillo.

Precio : 9.90 €

IVA NO INCLUIDO

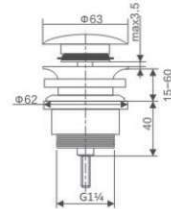

Ref. : VCC006

Apta para todos los lavabos y bidés, con o sin rebosadero.
Sistema de apertura/cierre garantizado para ciclos de 20.000 usos.
Rosca inferior de 1 1/4.
Sistema antical.
Fabricadas en latón,cromado.
Montaje rápido y sencillo.

Precio : 13 €

IVA NO INCLUIDO

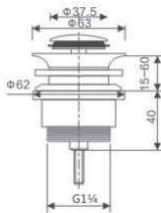

Ref. : VCC002

Apta para todos los lavabos y bidés, con o sin rebosadero.
Sistema de apertura/cierre garantizado para ciclos de 20.000 usos.
Rosca inferior de 1 1/4.
Sistema antical.
Fabricadas en latón, cromado.
Montaje rápido y sencillo.

Precio : 9.80 €

IVA NO INCLUIDO

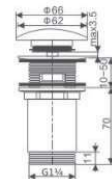

Ref. : VCC005 (Larga)

Apta para todos los lavabos y bidés, con o sin rebosadero.
Sistema de apertura/cierre garantizado para ciclos de 20.000 usos.
Rosca inferior de 1 1/4.
Sistema antical.
Fabricadas en latón, cromado.
Montaje rápido y sencillo.

Precio : 9.50 €

IVA NO INCLUIDO





Ref.: **FLX001**

Flexo de ducha de acero reforzado,
extensible de 150 a 170 cm.

Precio: **4.50 €**

IVA NO INCLUIDO



Ref.: **FLX004**

Flexo de ducha de acero reforzado,
extensible de 170 a 190 cm.

Precio: **4.95 €**

IVA NO INCLUIDO



Ref.: **FLX002**

Flexo de ducha de PVC de 150cm.

Precio: **9.00 €**

IVA NO INCLUIDO



Ref.: **FLX005/BL** (Blanco mate)

Flexo de ducha de PVC de 150cm.

Precio: **9.90 €**

IVA NO INCLUIDO



Ref.: **FLX003** (Peso 370 gr.)

Flexo de ducha de latón reforzado,
extensible de 150 a 170 cm.

Precio: **6.70 €**

IVA NO INCLUIDO



Ref.: **FLX005/NG** (Negro mate)

Flexo de ducha de PVC de 150cm.

Precio: **9.90 €**

IVA NO INCLUIDO





Ref.: **SFR001**

Precio: **25 €**

IVA NO INCLUIDO



9 780201 375220



Ref.: **SFR001/BL** (Blanco mate)

Precio: **28 €**

IVA NO INCLUIDO



8 410201 149620



Ref.: **SFR001/NG** (Negro mate)

Precio: **29 €**

IVA NO INCLUIDO



8 410201 150626



Ref.: **SFD002**

Precio: **21 €**

IVA NO INCLUIDO



9 780201 375329



Ref.: **SFD002/BL** (Blanco mate)

Precio: **24 €**

IVA NO INCLUIDO



8 410201 147626



Ref.: **SFD002/NG** (Negro mate)

Precio: **25 €**

IVA NO INCLUIDO



8 410201 148623





Ref.: KITR01

Modelo Rex
 Mango de ducha 5 posiciones, de ABS, ergonómico y antical.
 Flexo de acero reforzado extensible 170/190cm, con terminaciones en latón cromado.
 Soporte de ABS orientable y dirigible

Precio: 14 €
 IVA NO INCLUIDO

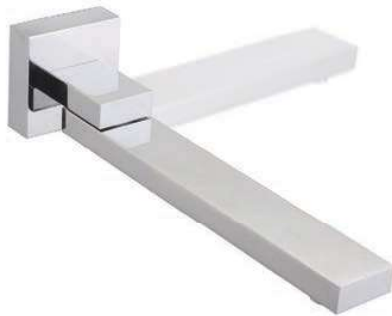

Caño de bañera de latón plegable

Material: Latón
 Acabado: Cromado

Ref.: CBP001

Precio: 48 €
 IVA NO INCLUIDO

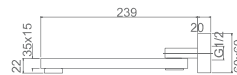

Ref.: SCL001

Precio: 9 €
 IVA NO INCLUIDO

Sifon cromado visto redondo
 Bote sífónico

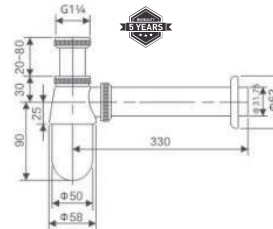

Material: Latón y zamak
 Acabado: Cromado



Material : Latón y zamak
Acababo : Cromado

Ref: **SCL002**

Precio: **15,80 €**

IVA NO INCLUIDO

Sifon cromado visto redondo
Bote sifónico

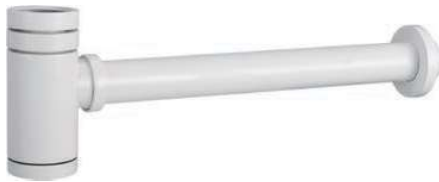
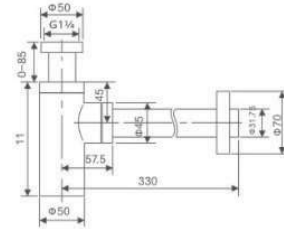

Material : Latón y zamak
Acababo : Blanco mate

Ref: **SCL002/BL**

Precio: **21 €**

IVA NO INCLUIDO

Sifon blanco mate visto redondo
Bote sifónico

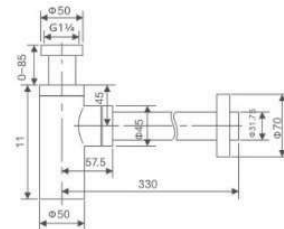

Material : Latón y zamak
Acababo : Negro mate

Ref: **SCL002/NG**

Precio: **21 €**

IVA NO INCLUIDO

Sifon negro mate visto redondo
Bote sifónico

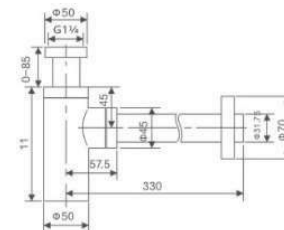

Material : Latón y zamak
Acababo : Cromado

Ref: **SCL003**

Precio: **28 €**

IVA NO INCLUIDO

Sifon cromado visto cuadrado
Bote sifónico

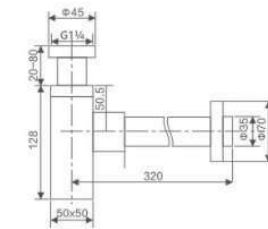

COMPLEMENTOS Y REPUESTOS





Ref.: **BPR001** (latón)

Precio: **20 €**

IVA NO INCLUIDO



Ref.: **BPR001/NG**

Precio: **29 €**

IVA NO INCLUIDO



Ref.: **BTR006** (latón)

Precio: **12 €**

IVA NO INCLUIDO



Ref.: **BTR006/NG**

Precio: **28 €**

IVA NO INCLUIDO

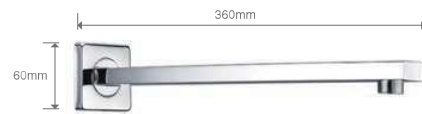

Ref.: **BPC003** (latón)

Precio: **28 €**

IVA NO INCLUIDO



Ref.: **BPC003/NG**

Precio: **39 €**

IVA NO INCLUIDO



Ref.: **BTC007** (latón)

Precio: **18 €**

IVA NO INCLUIDO



Ref.: **BTC007/NG**

Precio: **31 €**

IVA NO INCLUIDO







Ref.: **BPF002** (latón)

Precio: **21 €**
IVA NO INCLUIDO



Ref.: **BPC005**

Precio: **45 €**
IVA NO INCLUIDO



Ref.: **BPC005/NG**

Precio: **49 €**
IVA NO INCLUIDO



Ref.: **BPE004** (latón)

Precio: **29 €**
IVA NO INCLUIDO

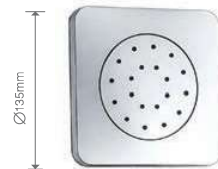

Ref.: **JCD002** (latón)

Precio: **69 €**
IVA NO INCLUIDO





Ref. :SMD005
 Precio : 18 €
 IVA NO INCLUIDO



Ref. :RR0001
 Precio : 14 €
 IVA NO INCLUIDO



Ref. :RR0002
 Precio : 11 €
 IVA NO INCLUIDO



Ref. :RR0003
 Precio : 4 €
 IVA NO INCLUIDO



Ref. :RR0004
 Precio : 5 €
 IVA NO INCLUIDO



Ref. :SMD006
 Precio : 26 €
 IVA NO INCLUIDO



Ref. :RR0006
 Cartucho cerámico 35 mm
 Precio : 9 €
 IVA NO INCLUIDO



Ref. :RR0007
 Cartucho cerámico 35 mm
 Precio : 10 €
 IVA NO INCLUIDO



Ref. :RR0005
 Precio : 8 €
 IVA NO INCLUIDO



Ref. :SMD004
 Precio : 20 €
 IVA NO INCLUIDO



Ref. :RR0017
 Precio : 8 €
 IVA NO INCLUIDO



Ref. :RR0008
 Cartucho termostatico VERNET
 Precio : 40 €
 IVA NO INCLUIDO



Ref. :RR0009
 Cartucho termostatico SEDAL
 Precio : 35 €
 IVA NO INCLUIDO





Ref.: **RR0011**

Precio: **60 €**
IVA NO INCLUIDO

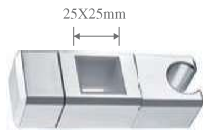

Ref.: **RR0016**

Precio: **8 €**
IVA NO INCLUIDO



Ref.: **SMD003**

Precio: **6 €**
IVA NO INCLUIDO



Ref.: **RR0012**

Precio: **100 €**
IVA NO INCLUIDO



Ref.: **RR0014**

Precio: **7 €**
IVA NO INCLUIDO



Ref.: **SMD002**

Precio: **19 €**
IVA NO INCLUIDO



Ref.: **RR0013**

Precio: **140 €**
IVA NO INCLUIDO



Ref.: **RR0015**

Precio: **5 €**
IVA NO INCLUIDO



Ref.: **SMD001**

Precio: **11 €**
IVA NO INCLUIDO

